

Product information

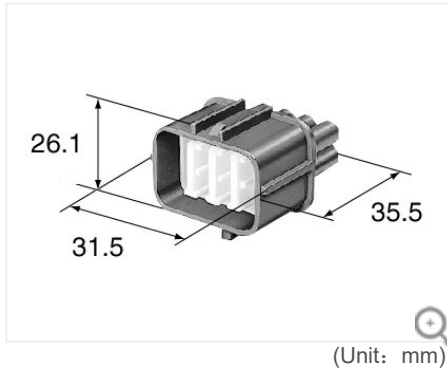

[Contact us for products](#)

6181-0075

This is old series

HW sealed series

Housing Inline

2.3mm(090)

Sealed/Unsealed	sealed
Male/Female	M
Way	8
Mating parts	<u>6189-0134</u> (HW sealed series)

Materials	PBT
Color	Dark Gray

Contact resistance	Initial	3mΩ Max.
	after durability tests	6mΩ Max.
Leak current	100μA Max.	
Insulation resistance	100MΩ Min.	
Seal	Initial	49.0kPa Min.
	after durability tests	29.4kPa Min.

Note TPA No.6918-0333

HW sealed series related products

Terminal (2)

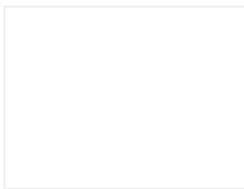

2.3mm 1500-0105

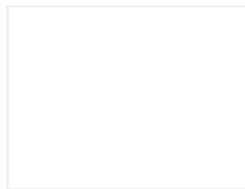

2.3mm 1500-0134

Wire seals (3)

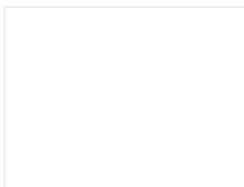

2.3mm 7165-0385

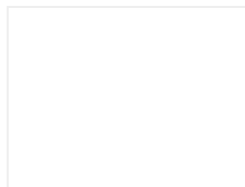

2.3mm 7165-0118

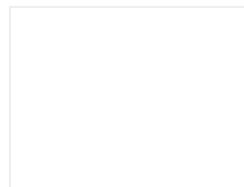

2.3mm 7165-0119

Dummy plugs (1)

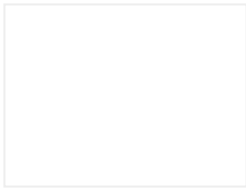

2.3mm 7161-9787