

REVISIONS

変更

P	LTR	DESCRIPTION	DATE	DWN	APVD
	F	REVISED ECR-17-012605	25JAN2018	YN	TK

WIRE RANGE ID MARK
("M" SIZE MARK)
(STAMPED ON BOTTOM)

端子識別マーク "M"
(底面に刻印)

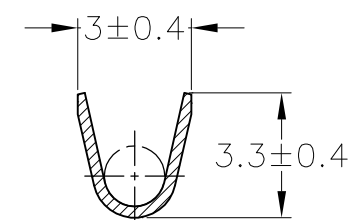
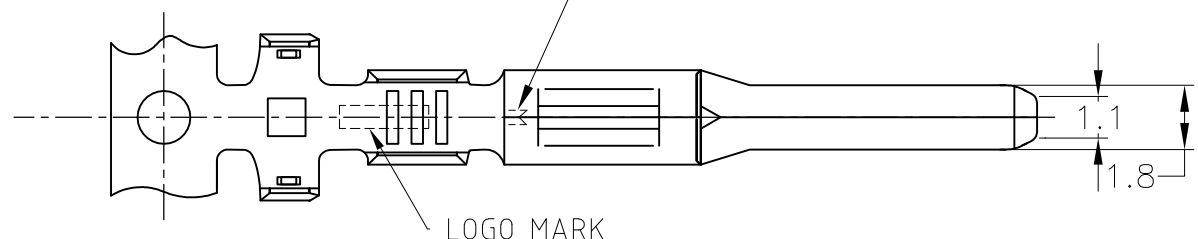

断面 A-A
SECT A-A

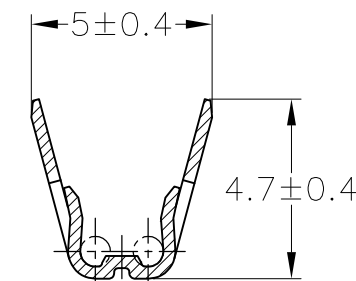

断面 B-B
SECT B-B

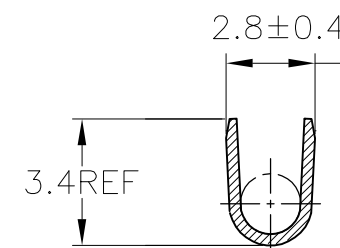
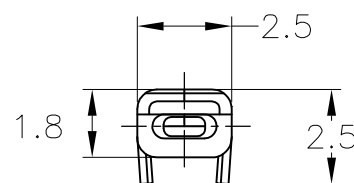
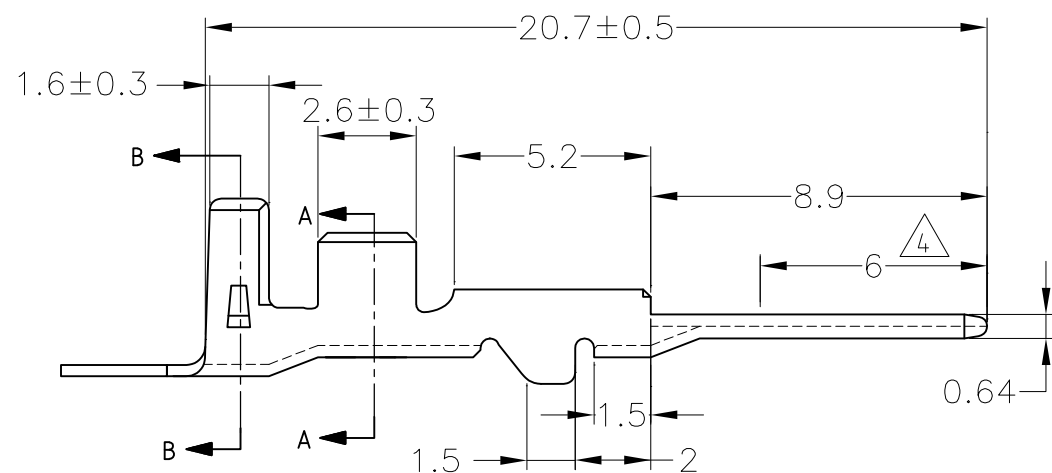

断面 A-A
SECT A-A
(175030のみ適用)
(ONLY 175030)

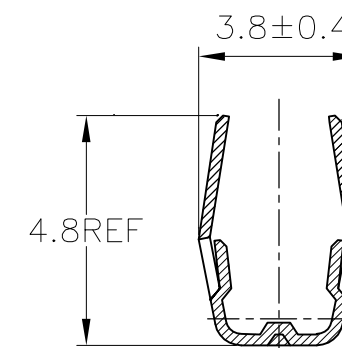

断面 B-B
SECT B-B
(175030のみ適用)
(ONLY 175030)

1. 製品規格; 108-5231, 108-5264

2. 嵌合相手端子型番; 173631 他

3. 圧着規格; 114-5092

△部分金めっき, 他はニッケルめっき

1. SPEC; 108-5231, 108-5264

2. RECEPTACLE CONTACT; 173631 etc

3. APPLICATION SPECIFICATION; 114-5092

△ SELECTIVE GOLD PLATING, REMAINDER NICKEL PLATING

TOLERANCES UNLESS OTHERWISE SPECIFIED: 一般公差

10 ≥	±0.2
30 ≥ > 10	±0.25
100 ≥ > 30	±0.3
ANGLE	±3°

WIRE RANGE 0.5~1.25mm ² (AWG#20-#16)		INSULATION DIA. 2~2.6mmφ		SEE DRAWING 173645-5		173645-5													
175030-3		部分金めっき SELECTIVE GOLD		リン青銅 板厚0.32 PHOS BRO. t0.32		173645-3													
175030-2		錫めっき済み PRE-TINNED		リン青銅 板厚0.32 PHOS BRO. t0.32		173645-2													
175030-1		錫めっき済み PRE-TINNED		黄銅 板厚0.32 BRASS t0.32		173645-1													
パラ端子型番 L/P NUMBER		仕上 FINISH		材料 MATERIAL		型番 PART NUMBER													
THIS DRAWING IS A CONTROLLED DOCUMENT.				DWN M.SUGAWARA 16MAY06		TE Connectivity Ltd. 070 SERIES TAB CONTACT													
DIMENSIONS: 単位: 耗 mm		TOLERANCES UNLESS OTHERWISE SPECIFIED: 一般公差		CHK T.SHINOHARA 16MAY06				NAME 名称											
		<table border="1"> <tr> <td>0 PLC</td> <td>±-</td> </tr> <tr> <td>1 PLC</td> <td>±-</td> </tr> <tr> <td>2 PLC</td> <td>±-</td> </tr> <tr> <td>3 PLC</td> <td>±-</td> </tr> <tr> <td>4 PLC</td> <td>±-</td> </tr> <tr> <td>ANGLES</td> <td>±-</td> </tr> </table>		0 PLC	±-			1 PLC	±-	2 PLC	±-	3 PLC	±-	4 PLC	±-	ANGLES	±-	APVD K.BETSUI 16MAY06	
0 PLC	±-																		
1 PLC	±-																		
2 PLC	±-																		
3 PLC	±-																		
4 PLC	±-																		
ANGLES	±-																		
MATERIAL 材料 SEE TABLE		FINISH 仕上 SEE TABLE		APPLICATION SPEC 取付適用規格 SEE NOTE		DRAWING NO 番号 A300779 C-173645													
WEIGHT -				SIZE A3		CAGE CODE 00779													
CUSTOMER DRAWING				SCALE 尺度 5:1		SHEET 1 OF 1													
				RESTRICTED TO -		REV F													