

## Product information

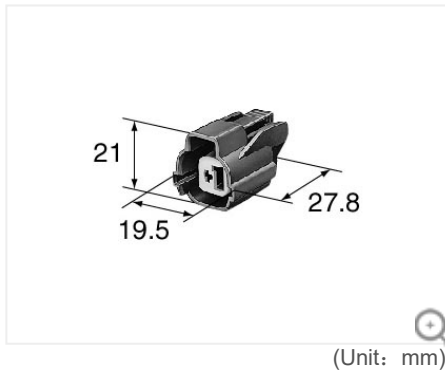

[Contact us for products](#)

# 6189-0386

**This is old series**

HW sealed series

Housing Inline

2.3mm(090)

Sealed/Unsealed	sealed
Male/Female	F
Way	1
Mating parts	<u>6181-0227</u> (HW sealed series)

Materials	PBT
Color	Dark Gray

Contact resistance	Initial	3mΩ Max.
	after durability tests	6mΩ Max.
Leak current	100μA Max.	
Insulation resistance	100MΩ Min.	
Seal	Initial	49.0kPa Min.
	after durability tests	29.4kPa Min.

Note	TPA No.6918-0698
------	------------------

## HW sealed series related products

### Terminal (3)

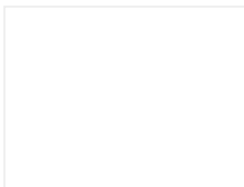

2.3mm 1500-0106

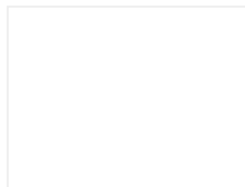

2.3mm 1500-0110

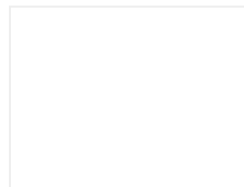

2.3mm 1500-0133

### Wire seals (3)

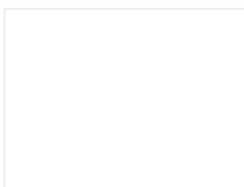

2.3mm 7165-0385

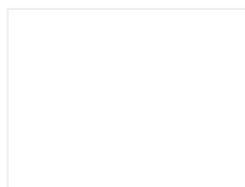

2.3mm 7165-0118

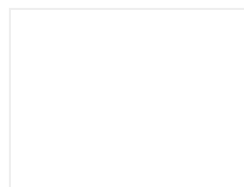

2.3mm 7165-0119

Dummy plugs (1)

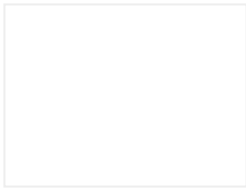

2.3mm 7161-9787