

Product information

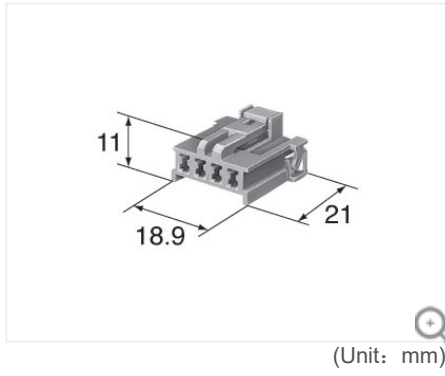

3D drawings

[Contact us for products](#)

6098-0243

This is old series

HD series

Housing Inline

2.3mm(090)

Sealed/Unsealed	unsealed
Male/Female	F
Way	4
Mating parts	<u>6098-0244</u> (HD series)

Materials	PBT
Color	Light Gray

Contact resistance	Initial	3mΩ Max.
	after durability tests	10mΩ Max.
Leak current	3mA Max.	
Insulation resistance	100MΩ Min.	

HD series related products

Terminal (2)

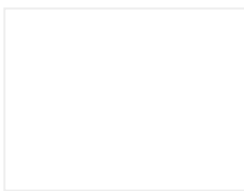

2.3mm 8240-4412

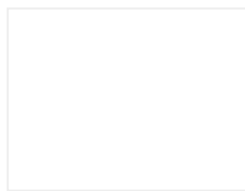

2.3mm 8240-4422