

Product information

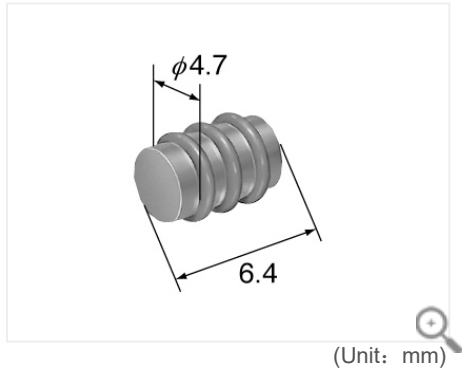

[Contact us for products](#)

7161-9787

[TS sealed series](#) [SL sealed series](#) [DL sealed series](#) [MT sealed series](#) [HW sealed series](#)

Dummy plugs

2.3mm(090) 1.5mm(060)

Tab Size 2.3mm(090) 1.5mm(060)

Male/Female Common

Materials NBR

Color Brown

Note Dummy plugs are used to blind unused terminal holes.
For 5mm Pitch housing

This part is applicable to use for both new type and old type.
Please inquire us for the details.

TS sealed series related products

Housing (10)

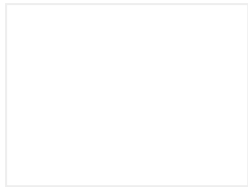

[0.64/2.3mm 6189-7077](#)

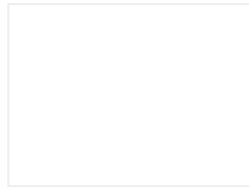

[0.64/2.3mm 6189-6934](#)

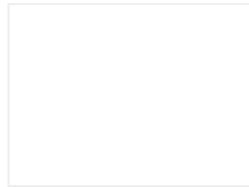

[0.64/2.3/4.8mm 6189-7094](#)

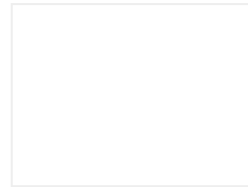

[0.64/2.3/4.8mm 6189-7809](#)

[Show all results](#)

SL sealed series related products

Housing (46)

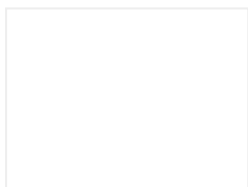

[1.5mm 6181-6492](#)

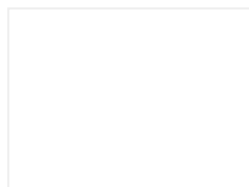

[1.5mm 6181-6509](#)

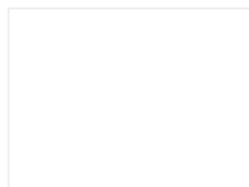

[1.5mm 6181-6614](#)

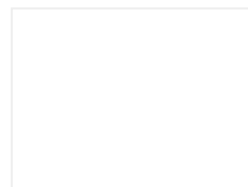

[1.5mm 6189-1073](#)

[Show all results](#)

DL sealed series related products

Housing (32)

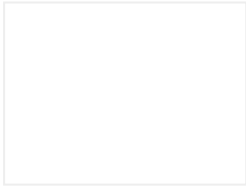

[2.3mm 6195-0066](#)

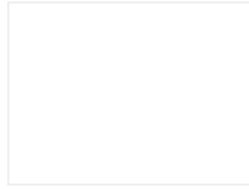

[2.3mm 6195-0240](#)

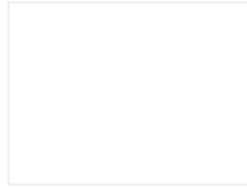

[2.3mm 6195-0003](#)

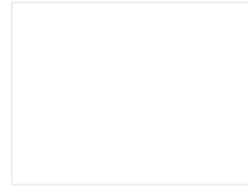

[2.3mm 6195-0006](#)

[Show all results](#)

MT sealed series related products

Housing (4)

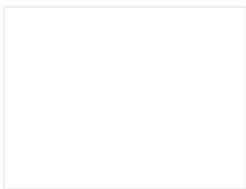

[2.3mm 6189-0035](#)

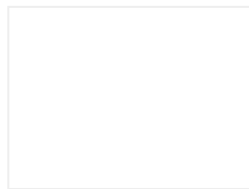

[2.3mm 6189-0039](#)

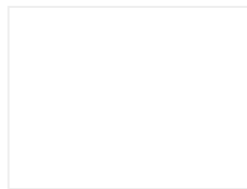

[2.3mm 6189-0056](#)

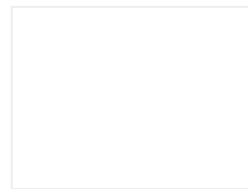

[2.3mm 6189-0060](#)

HW sealed series related products

Housing (18)

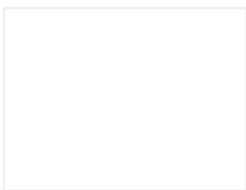

[2.3mm 6181-0227](#)

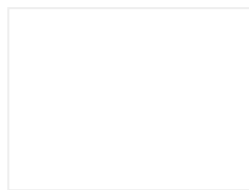

[2.3mm 6189-0386](#)

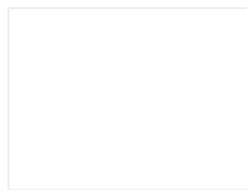

[2.3mm 6181-0070](#)

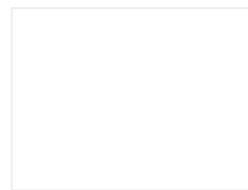

[2.3mm 6189-0129](#)