

Product information

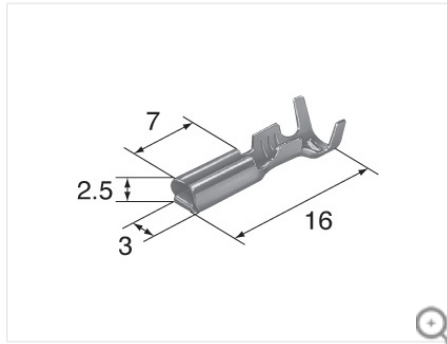

(Unit: mm)

[Contact us for products](#)

8240-4828

MT sealed series

Terminal For AV Wire

2.3mm(090)

Sealed/Unsealed	sealed
Male/Female	F
Tab Size	2.3mm(090)
Mating parts	<u>8230-4408</u> (MT sealed series)

Applicable wire size	2.0mm ²
Cable overall diameter (mm)	2.0-2.7
Materials	Heat-resistant copper alloy
Surface treatment	Tin-plated
Thickness (mm)	0.25
Contact resistance	Initial 3mΩ Max. after durability tests 10mΩ Max.
Leak current	100μA Max.
Insulation resistance	100MΩ Min.

MT sealed series 2.3mm(090) related products

Housing (24)

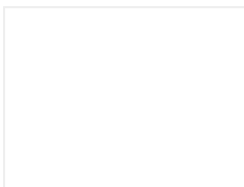

2.3mm 6180-1181

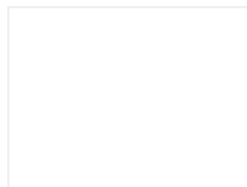

2.3mm 6180-2181

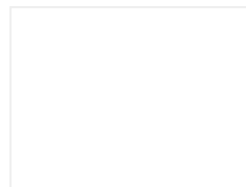

2.3mm 6180-2191

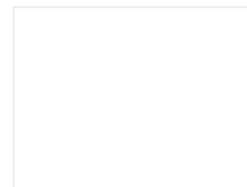

2.3mm 6180-2321

[Show all results](#)

Wire seals (3)

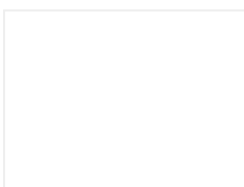

2.3mm 7160-8234

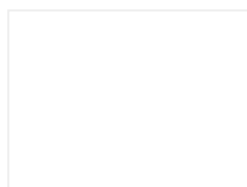

2.3mm 7160-9785

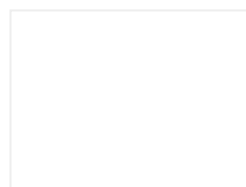

2.3mm 7161-9785