

Product information

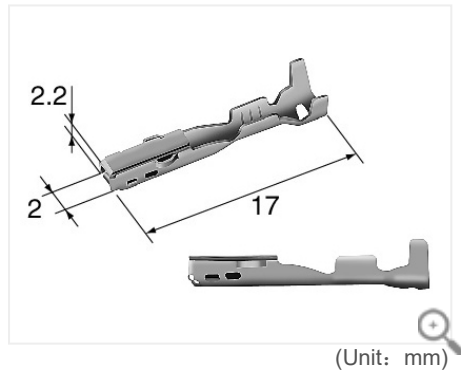

[Contact us for products](#)

8100-3067

[HX sealed series](#) [HV/HVG sealed series](#)

Terminal For AV Wire

1.0mm(040)

Sealed/Unsealed	sealed
Male/Female	F
Tab Size	1.0mm(040)
Size	S
Mating parts	8100-3177 (HX sealed series/HV/HVG sealed series)

Applicable wire size	0.3-0.5mm ²
Cable overall diameter (mm)	1.4-2
Materials	Heat-resistant copper alloy
Surface treatment	Tin-plated
Contact resistance	Initial 5mΩ Max. after durability tests 10mΩ Max.
Leak current	100μA Max.
Insulation resistance	100MΩ Min.

HV/HVG sealed series 1.0mm(040) related products

Housing (8)

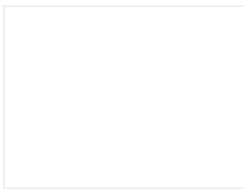

[1.0mm 6189-7036](#)

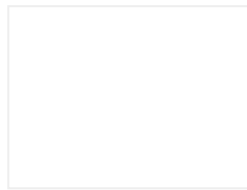

[1.0mm 6189-7052](#)

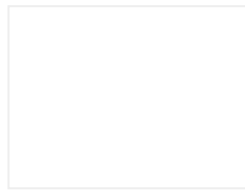

[1.0mm 6189-7037](#)

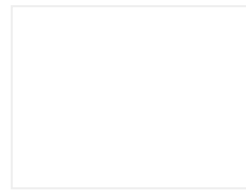

[1.0mm 6189-7058](#)

[Show all results](#)

Wire seals (3)

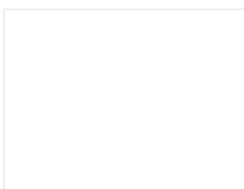

[1.0mm 7165-1075](#)

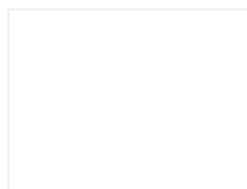

[1.0mm 7165-0621](#)

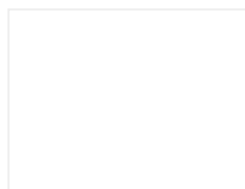

[1.0mm 7165-0622](#)

HX sealed series 1.0mm(040) related products

Housing (9)

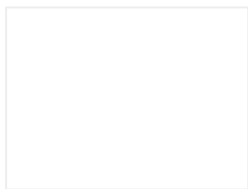

[1.0mm 6189-0940](#)

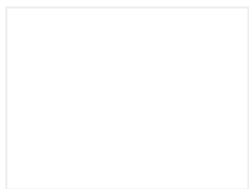

[1.0mm 6189-0890](#)

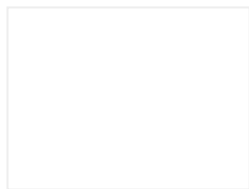

[1.0mm 6189-0891](#)

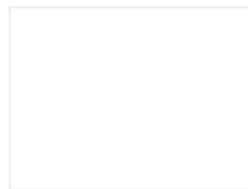

[1.0mm 6189-0887](#)

[Show all results](#)

Wire seals (3)

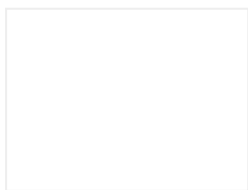

[1.0mm 7165-1075](#)

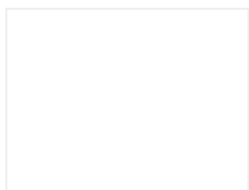

[1.0mm 7165-0621](#)

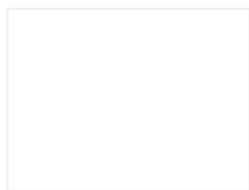

[1.0mm 7165-0622](#)