

## Product information

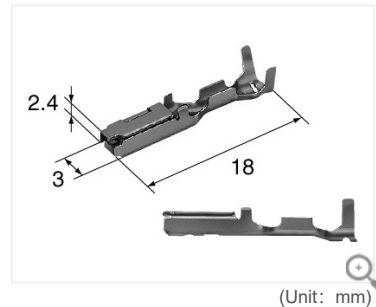

(Unit: mm)

[Contact us for products](#)

## 8240-4952

HX sealed series

Terminal For AV Wire

2.3mm(090)

Sealed/Unsealed	sealed
Male/Female	F
Tab Size	2.3mm(090)
Size	L
Mating parts	<a href="#">8230-4552</a> (DL sealed series/HX sealed series/TL sealed series/SL sealed series)

Applicable wire size	1.25-2.0mm <sup>2</sup>
Cable overall diameter (mm)	2.1-2.9
Materials	Heat-resistant copper alloy
Surface treatment	Tin-plated
Contact resistance	Initial 3mΩ Max. after durability tests 6mΩ Max.
Leak current	100μA Max.
Insulation resistance	100MΩ Min.

## HX sealed series 2.3mm(090) related products

## Housing (6)

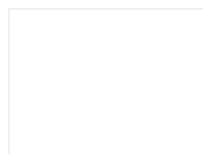
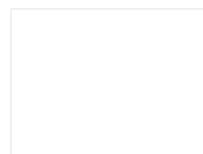
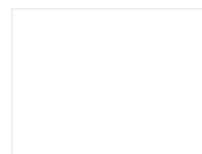
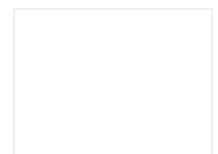
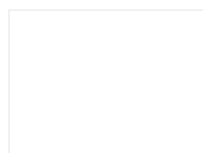
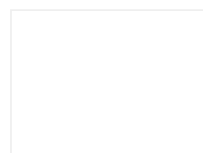
[2.3mm 6189-0591](#)[2.3mm 6189-0552](#)[2.3mm 6189-0593](#)[2.3mm 6189-0596](#)[2.3mm 6189-0617](#)[2.3/4.8mm 6189-0555](#)
[Hide some results](#)

## Wire seals (3)

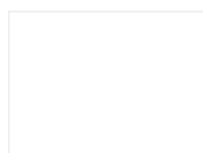
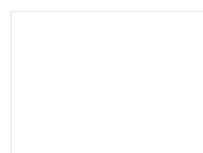
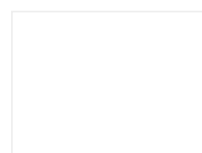
[2.3mm 7165-0385](#)[2.3mm 7165-0194](#)[2.3mm 7165-0198](#)

