

Product information

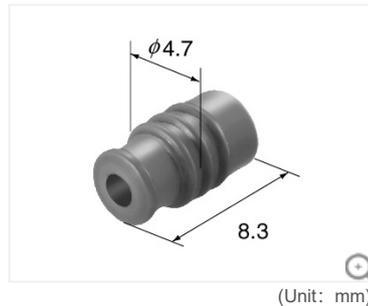

(Unit: mm)

[Contact us for products](#)

# 7165-0515

[SL sealed series](#) [TL sealed series](#)

Wire seals

2.3mm(090) 1.5mm(060)

Tab Size	2.3mm(090) 1.5mm(060)
Size	M
Male/Female	Common

Cable overall diameter (mm)	1.6-2.4
Materials	Silicone
Color	Gray

Note	This part is applicable to use for both new type and old type.
------	--

TL sealed series 2.3mm(090) 1.5mm(060) related products

Housing (5)

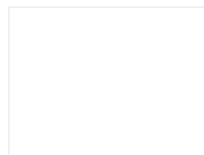

[2.3mm 6181-6658](#)

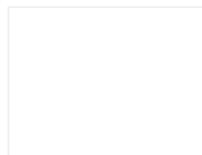

[2.3mm 6189-7214](#)

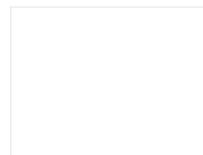

[2.3mm 6189-7189](#)

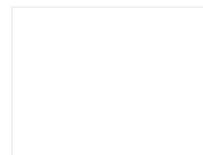

[2.3mm 6189-7188](#)

[Show all results](#)

Terminal (6)

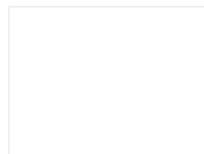

[2.3mm 8100-1427](#)

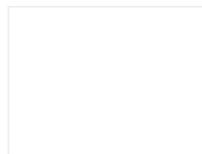

[2.3mm 8230-4472](#)

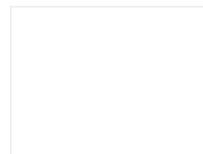

[2.3mm 8100-1429](#)

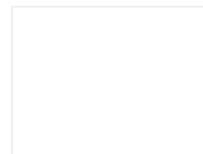

[2.3mm 8230-4562](#)

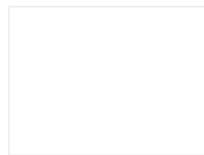

[2.3mm 8100-1428](#)

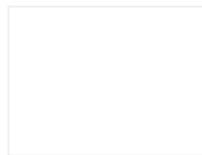

[2.3mm 8230-4552](#)

[Hide some results](#)

SL sealed series 2.3mm(090) 1.5mm(060) related products

Housing (47)

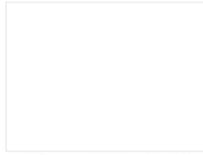

[1.5mm 6181-6492](#)

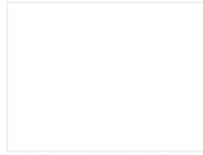

[1.5mm 6181-6509](#)

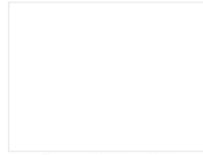

[1.5mm 6181-6614](#)

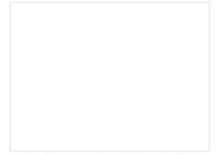

[1.5mm 6189-1073](#)

[Show all results](#)

Terminal (15)

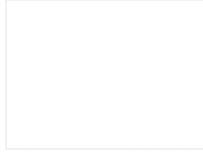

[1.5mm 8100-3388](#)

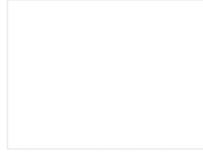

[1.5mm 8100-3397](#)

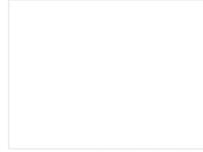

[1.5mm 8100-3402](#)

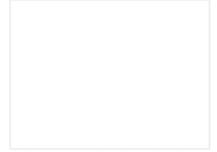

[1.5mm 8100-3504](#)

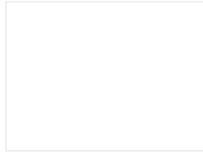

[1.5mm 8100-3389](#)

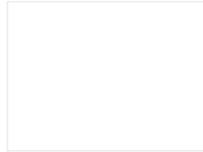

[1.5mm 8100-3398](#)

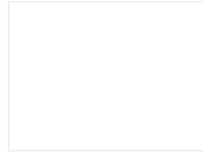

[1.5mm 8100-3403](#)

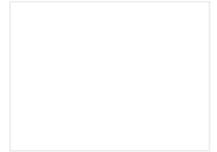

[1.5mm 8100-3390](#)

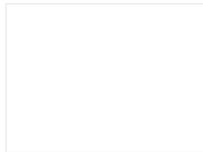

[1.5mm 8100-3399](#)

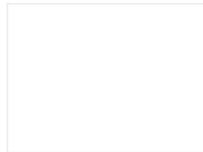

[2.3mm 8100-1427](#)

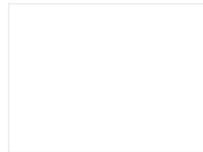

[2.3mm 8230-4472](#)

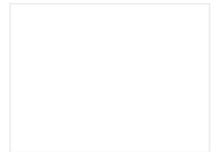

[2.3mm 8100-1429](#)

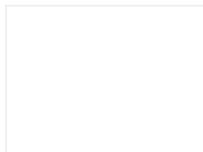

[2.3mm 8230-4562](#)

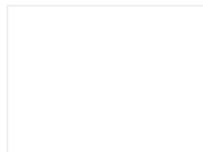

[2.3mm 8100-1428](#)

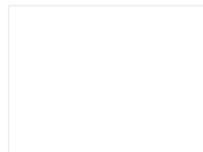

[2.3mm 8230-4552](#)