

Product information

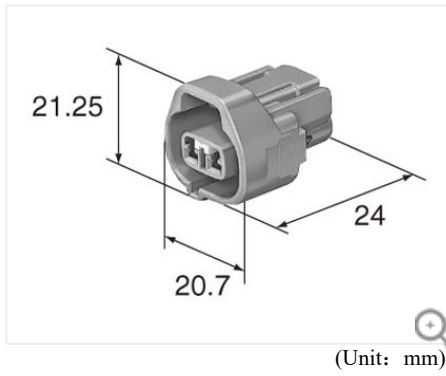

3D drawings

[Contact us for products](#)

6189-0249

TS sealed series

Housing Inline

2.3mm(090)

Sealed/Unsealed	sealed
Male/Female	F
Way	2
Mating parts	6188-0266 (TS sealed series)

Materials	PBT
Color	Gray

Contact resistance	Initial	3mΩ Max.
	after durability tests	10mΩ Max.
Leak current	100μA Max.	
Insulation resistance	100MΩ Min.	
Seal	Initial	50kPa Min.
	after durability tests	30kPa Min.

TS sealed series related products

Terminal (6)

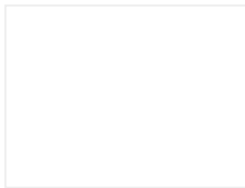

[2.3mm 8100-0460](#)

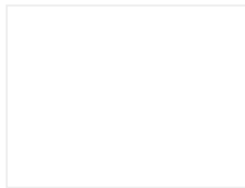

[2.3mm 8100-1344](#)

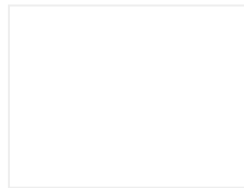

[2.3mm 8100-0461](#)

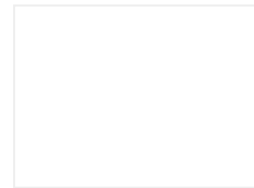

[2.3mm 8100-0594](#)

[Show all results](#)

Wire seals (4)

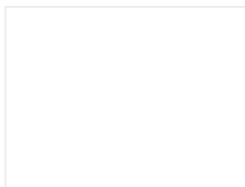

[2.3mm 7165-0842](#)

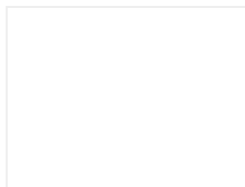

[2.3mm 7165-0349](#)

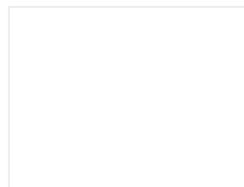

[2.3mm 7165-0395](#)

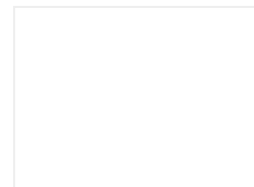

[2.3mm 7165-0351](#)

Dummy plugs (1)

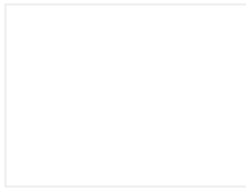

2.3mm 7160-9465

results