

Product information

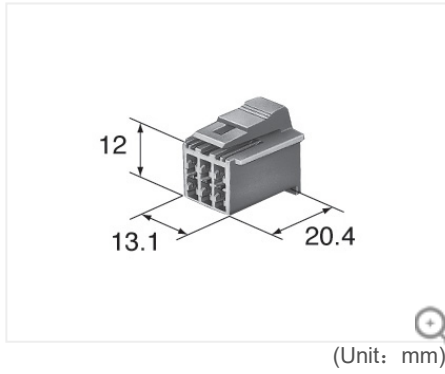

[Contact us for products](#)

6090-1218

This is old series

HM series

Housing Inline

2.3mm(090)

Sealed/Unsealed	unsealed
Male/Female	F
Way	6
Mating parts	6090-1149 (HM series) 6090-1124 (HM series)

Materials	66 Nylon
Color	Natural

Contact resistance	Initial	3mΩ Max.
	after durability tests	10mΩ Max.
Leak current	3mA Max.	
Insulation resistance	100MΩ Min.	

HM series related products

Terminal (2)

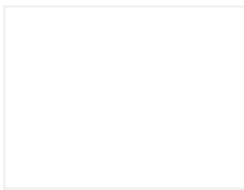

[2.3mm 8240-4412](#)

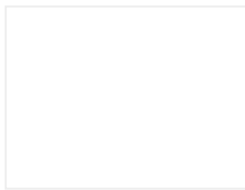

[2.3mm 8240-4422](#)