

Product information

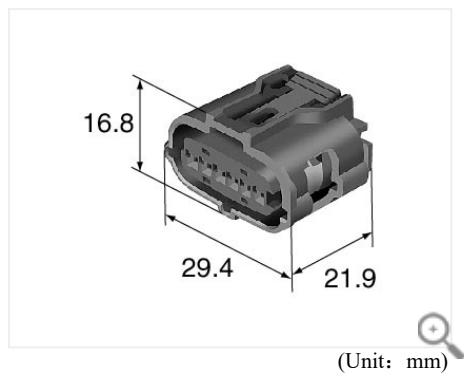

3D drawings

[Contact us for products](#)

6189-1083

TS sealed series

Housing **Inline**

0.64mm(025)

Sealed/Unsealed	sealed
Male/Female	F
Way	6

Materials	PBT
Color	Black

Contact resistance	Initial	8mΩ Max.
	after durability tests	16mΩ Max.
Leak current	50μA Max.	
Insulation resistance	100MΩ Min.	
Seal	Initial	50kPa Min.
	after durability tests	30kPa Min.

TS sealed series related products

Terminal (6)

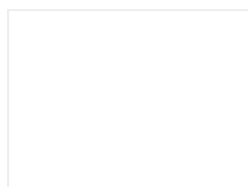

[0.64mm 8240-0336](#)

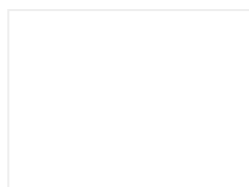

[0.64mm 8240-0337](#)

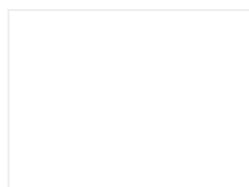

[0.64mm 8100-3455](#)

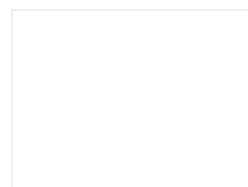

[0.64mm 8100-3456](#)

[Show all results](#)

Wire seals (5)

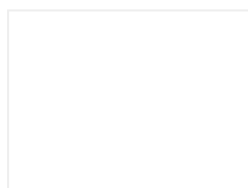

[0.64mm 7165-1043](#)

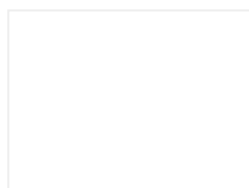

[0.64mm 7165-1312](#)

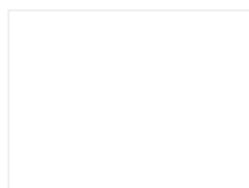

[0.64mm 7165-1198](#)

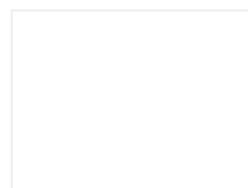

[0.64mm 7165-1199](#)

[Show all results](#)

Dummy plugs (1)

