

## Product information

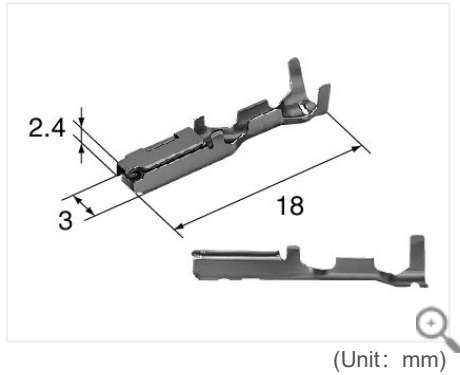

[Contact us for products](#)

# 8100-1429

[DL sealed series](#) [TL sealed series](#) [SL sealed series](#)

Terminal For AV Wire

2.3mm(090)

Sealed/Unsealed	sealed
Male/Female	F
Tab Size	2.3mm(090)
Size	M
Mating parts	<a href="#">8230-4562</a> (DL sealed series/HX sealed series/TL sealed series/SL sealed series)

Applicable wire size	0.75-0.85mm <sup>2</sup>
Materials	Heat-resistant copper alloy
Surface treatment	Tin-plated
Contact resistance	Initial 3mΩ Max. after durability tests 10mΩ Max.
Leak current	100μA Max.
Insulation resistance	100MΩ Min.

Note	This part is applicable to use for both new type and old type. For terminal selection, please contact our sales staff.
------	---

## TL sealed series 2.3mm(090) related products

### Housing (4)

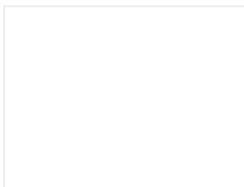

[2.3mm 6189-7214](#)

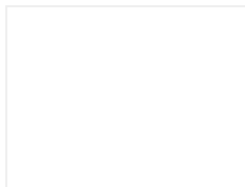

[2.3mm 6189-7189](#)

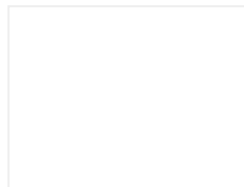

[2.3mm 6189-7188](#)

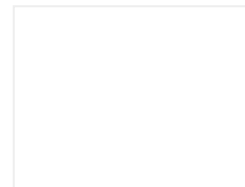

[2.3mm 6189-7190](#)

### Wire seals (6)

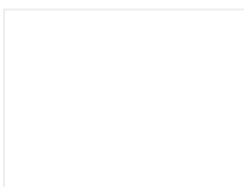

[1.5mm 7165-0516](#)

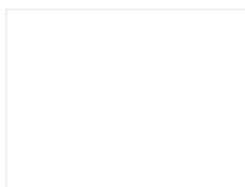

[1.5mm 7165-0515](#)

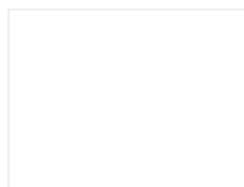

[1.5mm 7165-0514](#)

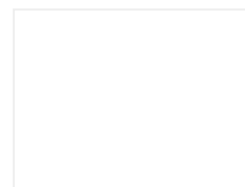

[2.3mm 7165-0516](#)





[2.3mm 7165-0515](#)



[2.3mm 7165-0514](#)

**Hide some results**

## SL sealed series 2.3mm(090) related products

### Housing (27)

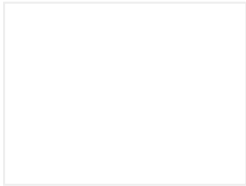

[2.3mm 6189-0639](#)

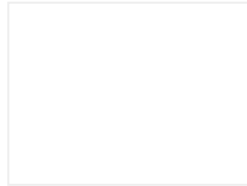

[2.3mm 6189-6920](#)

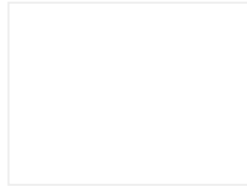

[2.3mm 6189-0640](#)

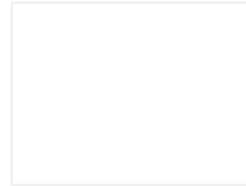

[2.3mm 6189-0641](#)

**Show all results**

### Wire seals (6)

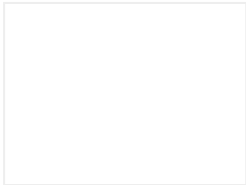

[1.5mm 7165-0516](#)

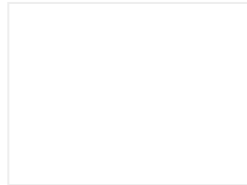

[1.5mm 7165-0515](#)

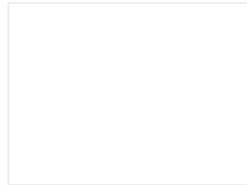

[1.5mm 7165-0514](#)

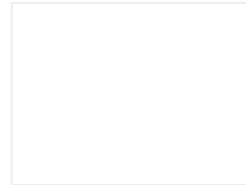

[2.3mm 7165-0516](#)

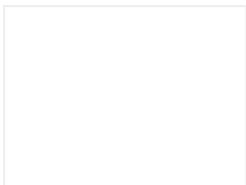

[2.3mm 7165-0515](#)

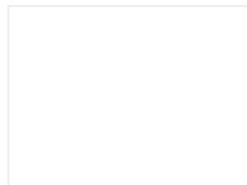

[2.3mm 7165-0514](#)

**Hide some results**

## DL sealed series 2.3mm(090) related products

### Housing (21)

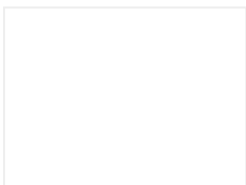

[2.3mm 6195-0066](#)

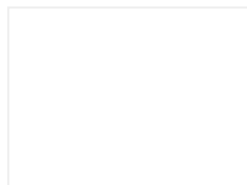

[2.3mm 6195-0003](#)

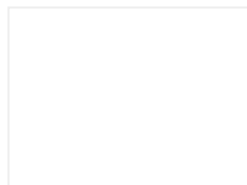

[2.3mm 6195-0041](#)

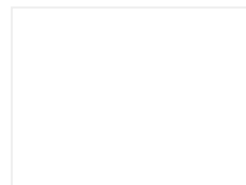

[2.3mm 6195-0043](#)

**Show all results**



Wire seals (3)

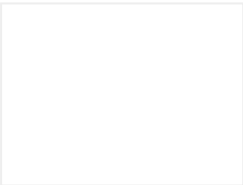

2.3mm 7165-0210

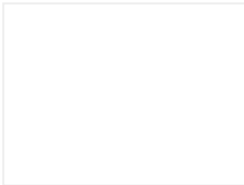

2.3mm 7165-0118

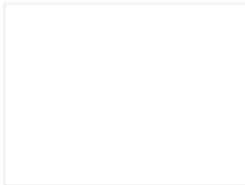

2.3mm 7165-0119