

## Product information

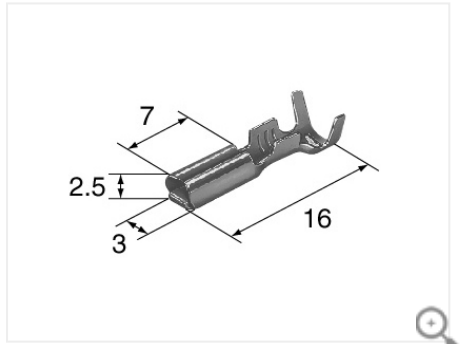

(Unit: mm)

[Contact us for products](#)

# 1500-0110

[MT sealed series](#) [HW sealed series](#)

Terminal For AV Wire

2.3mm(090)

Sealed/Unsealed	sealed
Male/Female	F
Tab Size	2.3mm(090)
Mating parts	<a href="#">1500-0105</a> (MT sealed series/HW sealed series/HM sealed series)

Applicable wire size	0.3-1.25mm <sup>2</sup>
Cable overall diameter (mm)	1.4-2.9
Materials	Heat-resistant copper alloy
Surface treatment	Tin-plated
Thickness (mm)	0.25
Contact resistance	Initial 3mΩ Max. after durability tests 10mΩ Max.
Leak current	100μA Max.
Insulation resistance	100MΩ Min.

## MT sealed series 2.3mm(090) related products

### Housing (24)

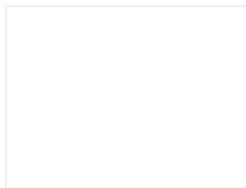

[2.3mm 6180-1181](#)

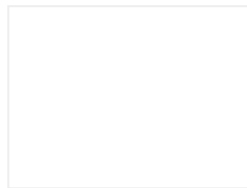

[2.3mm 6180-2181](#)

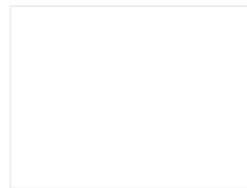

[2.3mm 6180-2191](#)

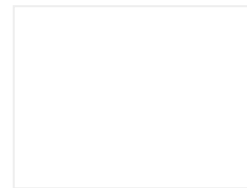

[2.3mm 6180-2321](#)

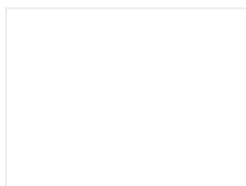

[2.3mm 6180-2591](#)

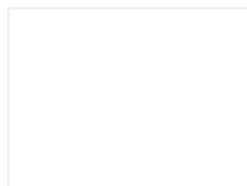

[2.3mm 6180-2617](#)

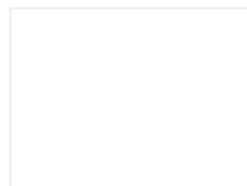

[2.3mm 6189-0031](#)

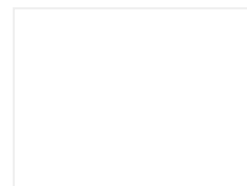

[2.3mm 6189-0033](#)

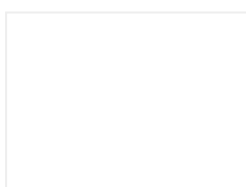

[2.3mm 6189-0035](#)

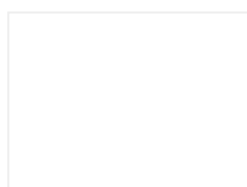

[2.3mm 6189-0039](#)

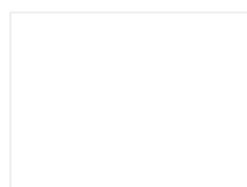

[2.3mm 6189-0056](#)

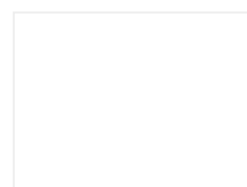

[2.3mm 6189-0060](#)



[2.3mm 6180-3241](#)



[2.3mm 6180-3261](#)



[2.3mm 6187-3901](#)



[2.3mm 6189-0027](#)

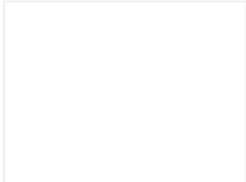

[2.3mm 6189-0028](#)

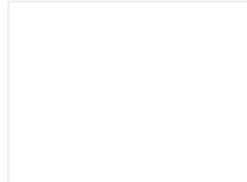

[2.3mm 6180-4181](#)

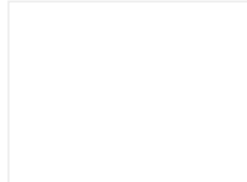

[2.3mm 6180-4593](#)

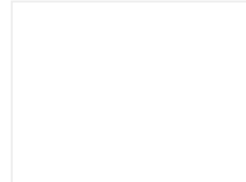

[2.3mm 6180-4771](#)

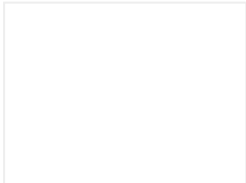

[2.3mm 6180-6181](#)

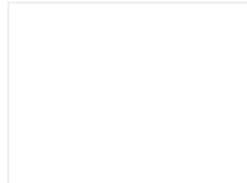

[2.3mm 6180-6591](#)

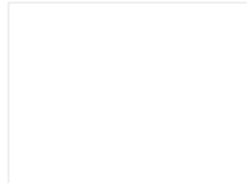

[2.3mm 6180-6771](#)

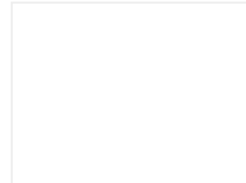

[2.3mm 6189-0029](#)

**Hide some results**

#### Wire seals (3)

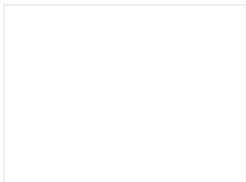

[2.3mm 7160-8234](#)

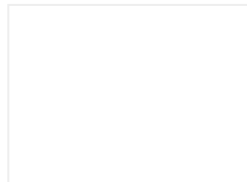

[2.3mm 7160-9785](#)

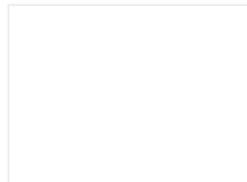

[2.3mm 7161-9785](#)

#### HW sealed series 2.3mm(090) related products

##### Housing (9)

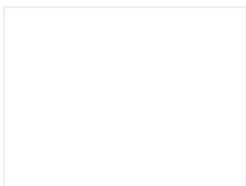

[2.3mm 6189-0386](#)

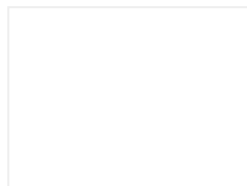

[2.3mm 6189-0129](#)

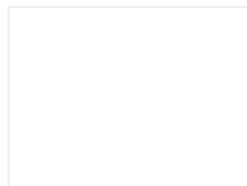

[2.3mm 6189-0130](#)

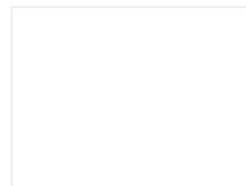

[2.3mm 6189-0131](#)

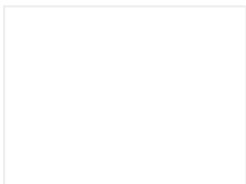

[2.3mm 6189-0132](#)

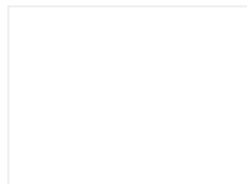

[2.3mm 6189-0133](#)

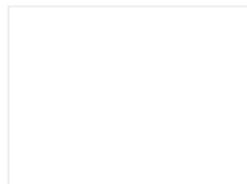

[2.3mm 6189-0134](#)

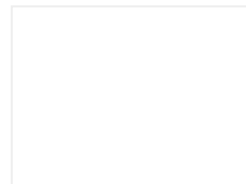

[2.3mm 6189-0135](#)

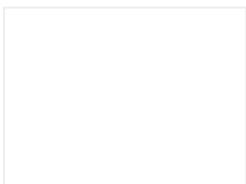

[2.3mm 6189-0136](#)

Hide some results

Wire seals (3)

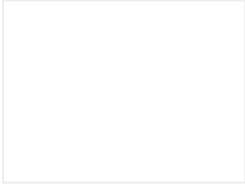

2.3mm 7165-0385

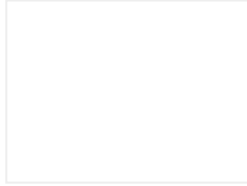

2.3mm 7165-0118

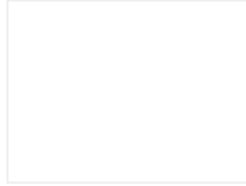

2.3mm 7165-0119