

## Product information

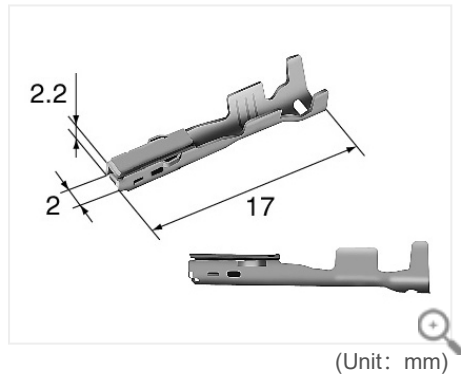

[Contact us for products](#)

# 8100-3068

[HX sealed series](#) [HV/HVG sealed series](#)

Terminal For AV Wire

1.0mm(040)

Sealed/Unsealed	sealed
Male/Female	F
Tab Size	1.0mm(040)
Size	M
Mating parts	<a href="#">8100-3178</a> (HX sealed series/HV/HVG sealed series)

Applicable wire size	0.75-1.25mm <sup>2</sup>
Materials	Heat-resistant copper alloy
Surface treatment	Tin-plated
Contact resistance	Initial 5mΩ Max. after durability tests 10mΩ Max.
Leak current	100μA Max.
Insulation resistance	100MΩ Min.

## HV/HVG sealed series 1.0mm(040) related products

### Housing (8)

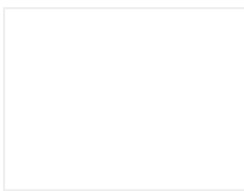

[1.0mm 6189-7036](#)

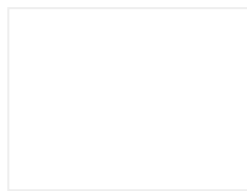

[1.0mm 6189-7052](#)

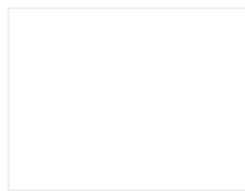

[1.0mm 6189-7037](#)

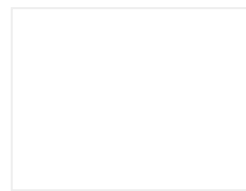

[1.0mm 6189-7058](#)

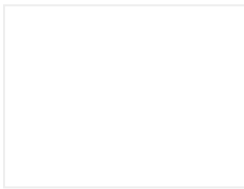

[1.0mm 6189-7039](#)

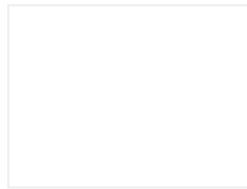

[1.0mm 6189-6909](#)

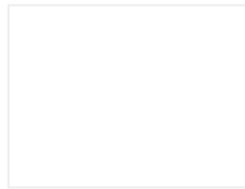

[1.0mm 6189-7040](#)

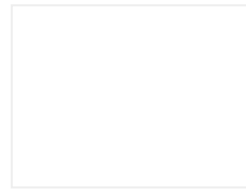

[1.0mm 6189-6906](#)

[Hide some results](#)

### Wire seals (3)

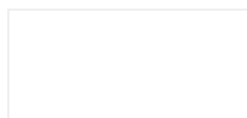
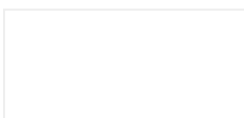



1.0mm 7165-1075



1.0mm 7165-0621



1.0mm 7165-0622

## HX sealed series 1.0mm(040) related products

### Housing (9)

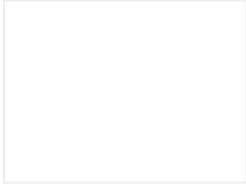

1.0mm 6189-0940

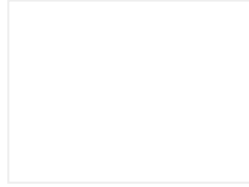

1.0mm 6189-0890

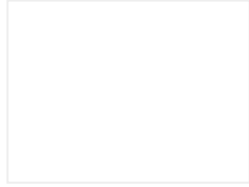

1.0mm 6189-0891

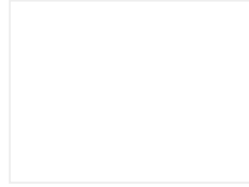

1.0mm 6189-0887

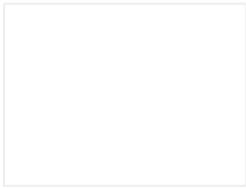

1.0mm 6189-0968

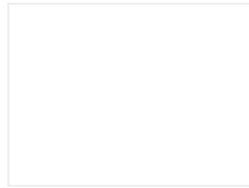

1.0mm 6189-1081

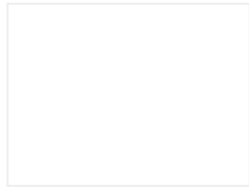

1.0mm 6189-1012

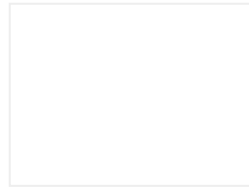

1.0mm 6189-0855

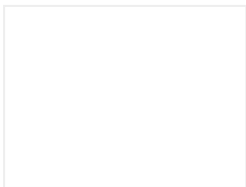

1.0/4.8mm 6189-6863

Hide some results

### Wire seals (3)

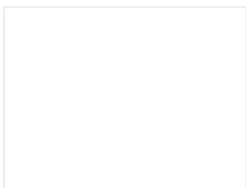

1.0mm 7165-1075

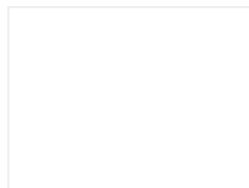

1.0mm 7165-0621

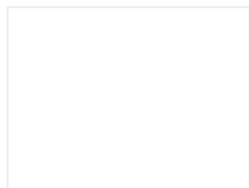

1.0mm 7165-0622