

5

4

3

2

1

受控 CONTROLLED DOCUMENT					
编号 P/N	32-2098UL	版本 Rev	01	日期 Rel'd Date	May8,09

DRAWING NO.
32-2098UL

REVISIONS				
01	OFFICIAL RELEASE			
	04-24-09	T W	T W	T W

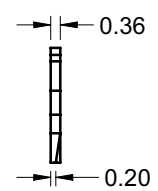
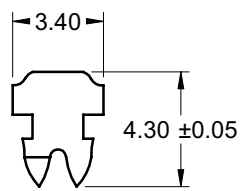
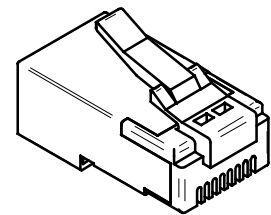
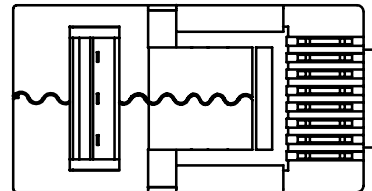
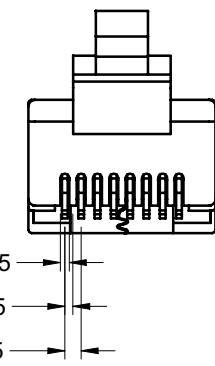
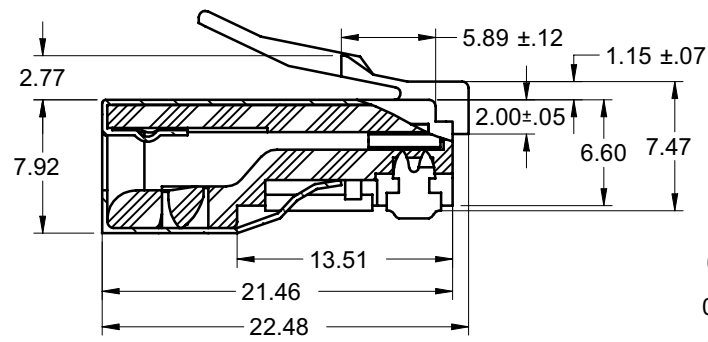
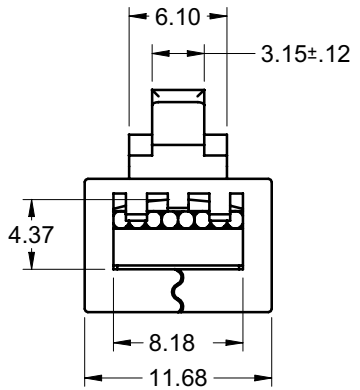
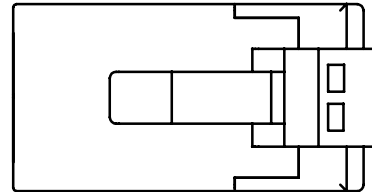

CONTACT

NOTES:

1. ELECTRICAL SPECIFICATIONS

INSULATION RESISTANCE: 1000 MEGOHMS
WITHSTAND VOLTAGE: 1000V,AC/ MINUTE

2. MECHANICAL SPECIFICATIONS

CONTACT MATERIAL: PHOSPHOR BRONZE 0.3MM THICKNESS
CONTACT PLATING: 50 MICRO-INCH GOLD PLATE OVER 100
MICRO-INCH NICKEL PLATING

HOUSING MATERIAL: POLYCARBONATE
DURABILITY: 1000 CYCLES MIN
UL FLAMABILITY RATING: 94-V0

3. ENVIRONMENTAL SPECIFICATIONS

TEMPERATURE RANGE: -40 °C TO +70°C

4. FOR FLAT OVAL OR ROUND CABLE

5. FOR SOLID OR STRANDED WIRE APPLICATIONS

THIS DRAWING TO BE INTERPRETED
PER ANSI Y 14.5M - 1994

COMPANY CONFIDENTIAL

TOLERANCE UNLESS OTHERWISE SPECIFIED	DRAWN BY	DATE
DECIMALS	TERRY.W	04-24-09
mm	CHECKED BY	DATE
X	TERRY.W	04-24-09
X.X	APPROVED BY	DATE
X.XX	THOMAS	04-24-09
ANGLES	U/M:	mm
THIS DRAWING WAS PRODUCED BY COMPUTER, DO NOT SCALE DRAWING OR UPDATE MANUALLY.		

Connectivity Solutions

EMERSON
Network Power

TITLE
RJ45 MOD PLUG SHIELDED,SOLID,U

SHEET 1 OF 1

DRAWING NO.
32-2098UL

SIZE
C

5

4

3

2

1