

# CRIMP TERMINAL

## 3060 & 3079 SERIES

### Features

- Used in 3940, 3990, 5000, 5080 and 7500 series socket
- Accommodates wire ranges from AWG 18 to 24
- Material: Pre-finned copper alloy
- Mates with 1.14mm(.045") square or round pin
- For other options consult the Sales Office

### Dimensional Information

### Ordering and Dimensional Information

Reel Quantity	Part Number	Material	Wire Ranges	Insulation Diameter
5,000 pcs. (Reel)	3079 - 2000	Pre-finned copper Alloy	AWG 18 - 24	2.48mm. Max.
Loose Piece	3060 - 2002	Pre-finned copper Alloy	AWG 18 - 24	2.48mm. Max.

### 3060 - 2002

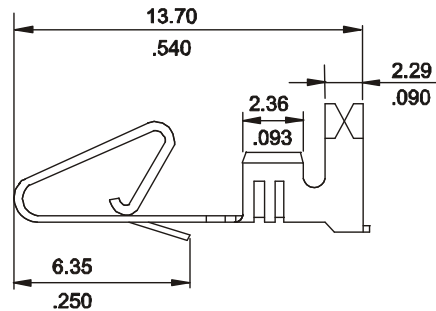
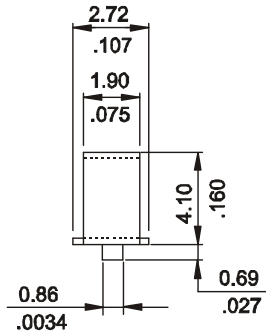

### 3079 - 2002

