

## Product information

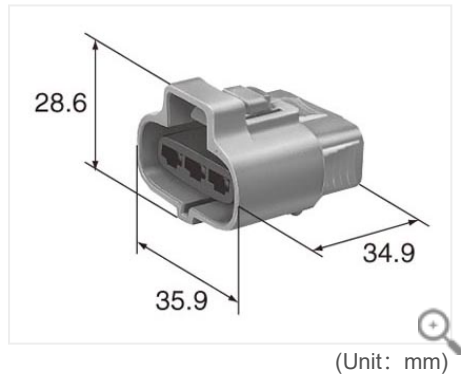

3D drawings

[Contact us for products](#)

# 6189-0165

TS sealed series

Housing Inline

4.8mm(187)

Sealed/Unsealed	sealed
Male/Female	F
Way	3
Mating parts	<u>6188-0129</u> (TS sealed series)

Materials	PBT
Color	Gray

Contact resistance	Initial	3mΩ Max.
	after durability tests	10mΩ Max.
Leak current		100μA Max.
Insulation resistance		100MΩ Min.
Seal	Initial	50kPa Min.
	after durability tests	30kPa Min.

## TS sealed series related products

### Terminal (3)

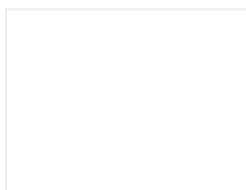

4.8mm 8100-0466

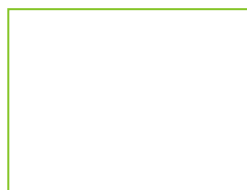

4.8mm 8100-0467

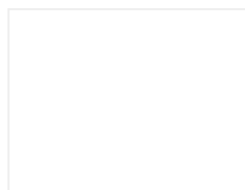

4.8mm 8100-0468

### Wire seals (4)

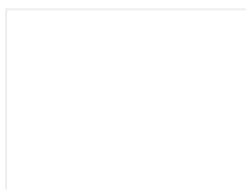

4.8mm 7165-0346

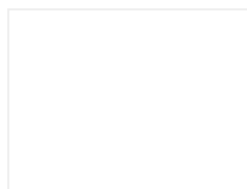

4.8mm 7165-0347



4.8mm 7165-0356

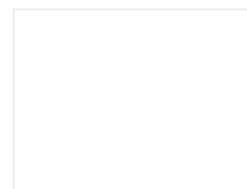

4.8mm 7165-0348

### Dummy plugs (1)

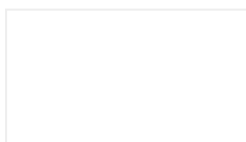

4.8mm 7165-0145