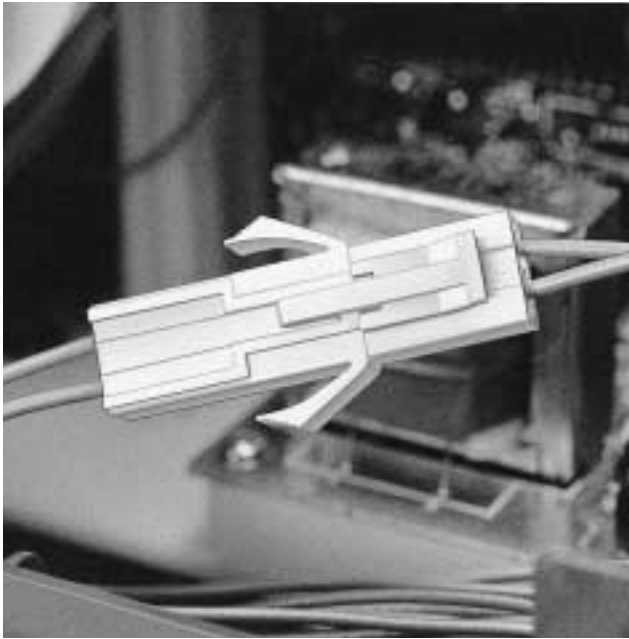

JST

Crimp

4.5mm
(.177") pitch

EL CONNECTOR

Disconnectable Crimp style Wire-to-wire connectors

The contacts for the compact EL connector can be easily inserted into the connector housings. The plug housing and the receptacle housing can be smoothly mated even if they are mechanically distorted.

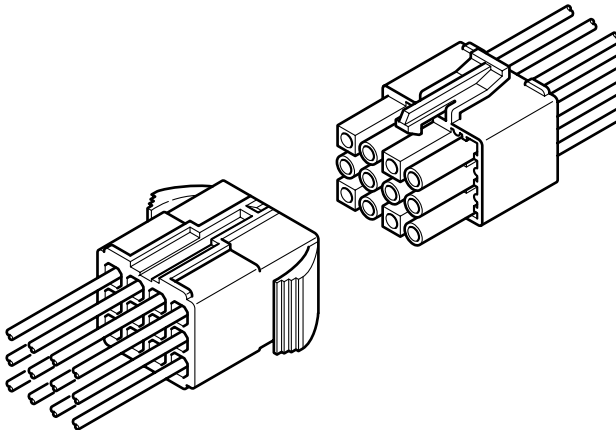

Features

• **Easy insertion and secure installation of contacts**

Each contact has a pair of locking lances so that the contact can be installed and symmetrically locked in the housing.

A lance retraction prevention mechanism is also provided so that the contact will be securely held in the housing. The lances have sufficient clearance to allow the contacts to be easily inserted into the housing.

• **A smooth connection even when pried during mating**

The contact is held by the housing along a wide surface area.

This reduces the deflection of the contact and ensures a smooth, safe connection even when pried during mating.

• **Durable arm lock mechanism**

The arm lock mechanism of the housing is slit to prevent stress concentration during connection. Thus, it is highly durable and will survive repeated matings.

• **Two contact styles**

Two different kinds of crimp contacts are available for convenient branching or internal jumpering.

Specifications

- Current rating: 10A AC, DC max.
 - Voltage rating: 300V AC, DC max.
 - Temperature range: -25°C to +90°C
(including temperature rise in applying electrical current)
 - Contact resistance: Initial value/7m Ω max.
After environmental testing/10m Ω max.
 - Insulation resistance: 1,000M Ω min.
 - Withstanding voltage: 1,500V AC/minute
 - Applicable wire: AWG #26 to #16
0.13 to 1.25mm²
 - Applicable panel thickness: 0.8 to 2.0mm (.031" to .079")
- * Contact JST for details.

Note: The current rating varies depending on the number of circuits and the wire size used in each connector. The table below lists the current rating as a function of the number of circuits and the wire size.

Current unit: A

| Circuits | Wire size (AWG) | | | | | |
|----------|-----------------|-----|-----|-----|-----|-----|
| | #16 | #18 | #20 | #22 | #24 | #26 |
| 2 | 10 | 6 | 5 | 4 | 4 | 3 |
| 3 | 10 | 6 | 5 | 4 | 4 | 3 |
| 4 | 10 | 6 | 5 | 4 | 4 | 3 |
| 6 | 8 | 5 | 4 | 3 | 3 | 3 |
| 9 | 6 | 4 | 3 | 3 | 2 | 2 |
| 12 | 6 | 4 | 3 | 3 | 2 | 2 |
| 15 | 6 | 4 | 3 | 3 | 2 | 2 |

Standards

Ⓜ Recognized E60389

Ⓢ Certified LR20812

△ R75052

△ Approved according to DIN/VDE 0627<Reg. No. 3516>

Current rating: AC 250V, DC 300V

Voltage rating: 6A, 5A, 4A, 3A

Insulation group: B

Kind of protection: IP 00

Applicable wires: AWG 18-26

Creepage current stability: KB 380

Contact

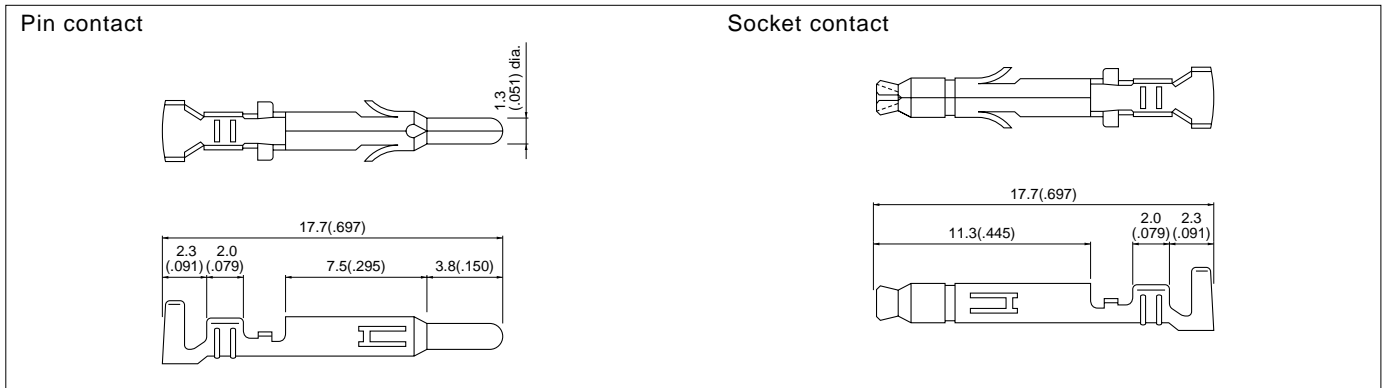

| Model No. | | Applicable wire | | | Q'ty / reel |
|-----------------------|-----------------------|--------------------|----------------|---|-------------|
| Pin contact | Socket contact | mm ² | AWG # | Insulation O.D. mm(in.) | |
| SLM-01T-P1.3E | SLF-01T-P1.3E | 0.13 to 0.5 | 26 to 20 | 1.3 to 2.7 (.051 to .106) | 6,000 |
| SLM-41T-P1.3E | SLF-41T-P1.3E | 0.5 to 1.25 | 20 to 16 | 1.9 to 3.4 (.075 to .134) | 4,000 |
| *SLM-42T-P1.3E | *SLF-42T-P1.3E | 0.3+0.3 to 0.5+0.5 | 22+22 to 20+20 | 1.7+1.7 to 2.0+2.0 (.067+.067 to .079+.079) | |

Material and Finish

Phosphor bronze, tin-plated

Note: 1. Contact denoted by * is used for two wires.
2. Contact JST for special products.

Housing



Material: Nylon 6, UL94V-0, white

| Circuits | Voltage rating | Current rating | Receptacle housing(for pin contact) | | Plug housing(for socket contact) | |
|----------|----------------|----------------|-------------------------------------|------------|----------------------------------|------------|
| | | | Model No. | Q'ty / bag | Model No. | Q'ty / bag |
| 2 | 300V | 10.0A | ELR-02V | 500 | ELP-02V | 500 |
| | | | ELR-02VF | 500 | | |
| 3 | 300V | 10.0A | ELR-03V | 500 | ELP-03V | 500 |

EL CONNECTOR

Housing

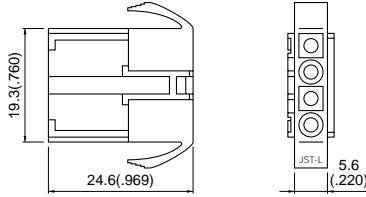
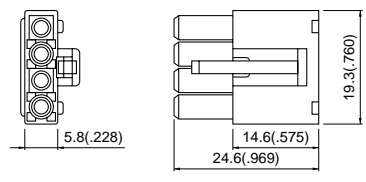
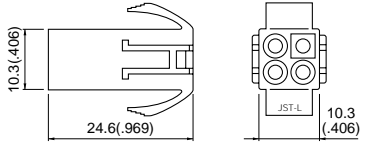
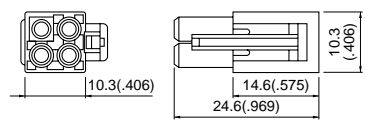
Material: Nylon 6, UL94V-0, white

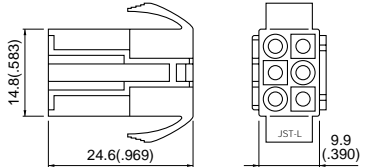
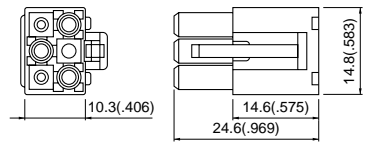
| Circuits | Voltage rating | Current rating | Receptacle housing(for pin contact) | | Plug housing(for socket contact) | |
|----------|----------------|----------------|---|------------|---|------------|
| 4 | 300V | 10.0A | ELR-04V  | Q'ty / bag | ELP-04V  | Q'ty / bag |
| | | | ELR-04NV  | Q'ty / bag | ELP-04NV  | Q'ty / bag |
| | | | ELR-04NVF  | 500 | 500 | |
| 6 | 300V | 8.0A | ELR-06V  | Q'ty / bag | ELP-06V  | Q'ty / bag |
| | | | 500 | 500 | | |

Housing

Material: Nylon 6, UL94V-0, white

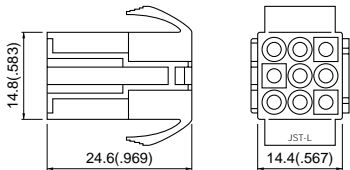
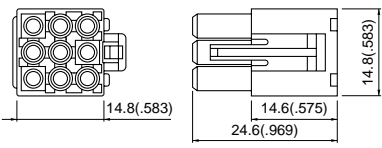
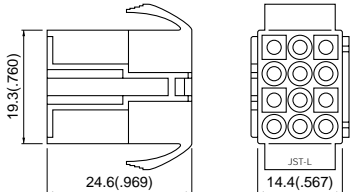
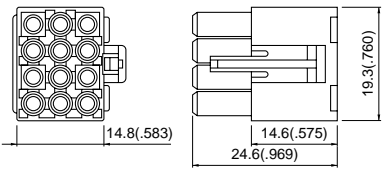
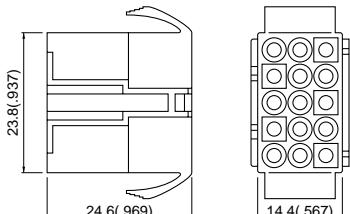
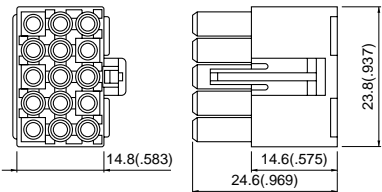
| Circuits | Voltage rating | Current rating | Receptacle housing(for pin contact) | | Q'ty / bag | Plug housing(for socket contact) | | Q'ty / bag |
|----------|----------------|----------------|---|--|------------|---|--|------------|
| 9 | 300V | 6.0A | ELR-09V  | | 500 | ELP-09V  | | 500 |
| 12 | 300V | 6.0A | ELR-12V  | | 500 | ELP-12V  | | 500 |
| 15 | 300V | 6.0A | ELR-15V  | | 500 | ELP-15V  | | 500 |

Note:

1. ELR-02VF and ELR-04NVF are exclusively for free hanging. The other circuits can be used either for panel mounted or free hanging. The panel hole dimensions are given on the next page.
2. Contact JST for special products.

EL CONNECTOR

Contact position location numbers

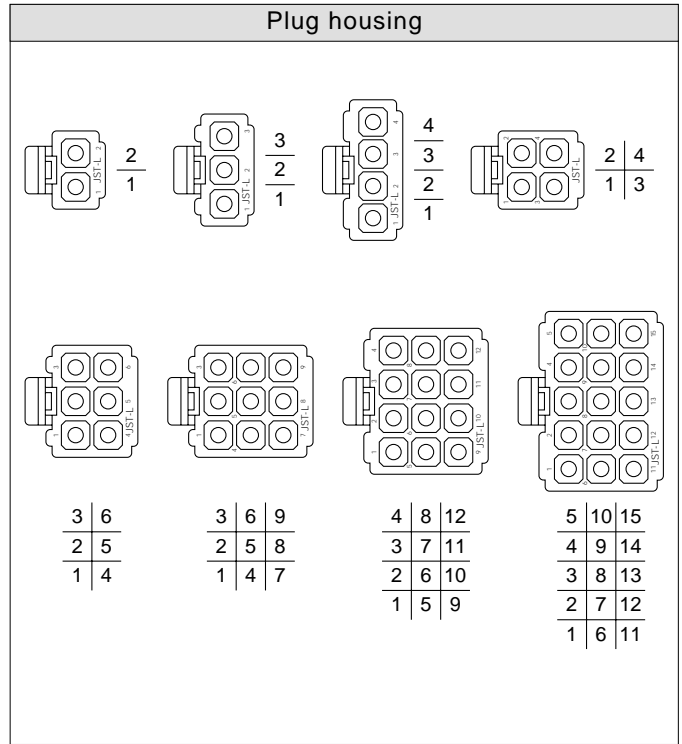
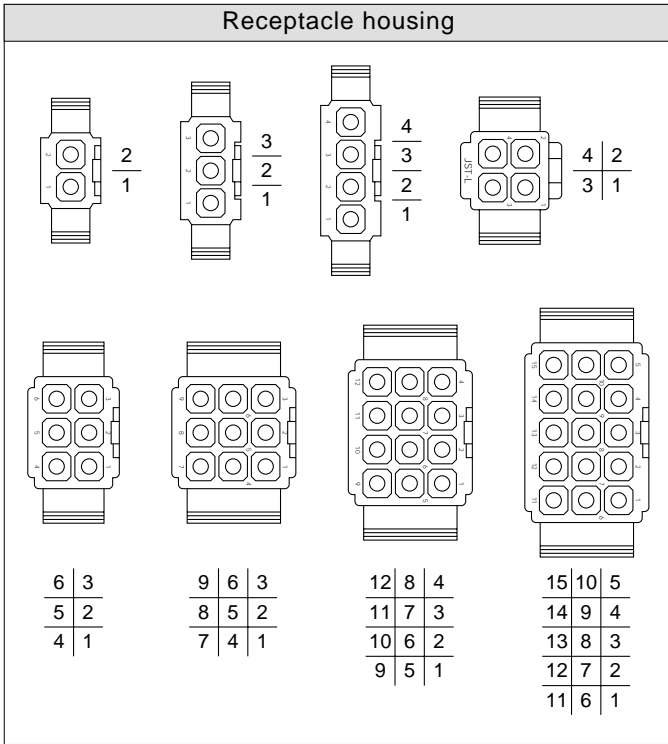
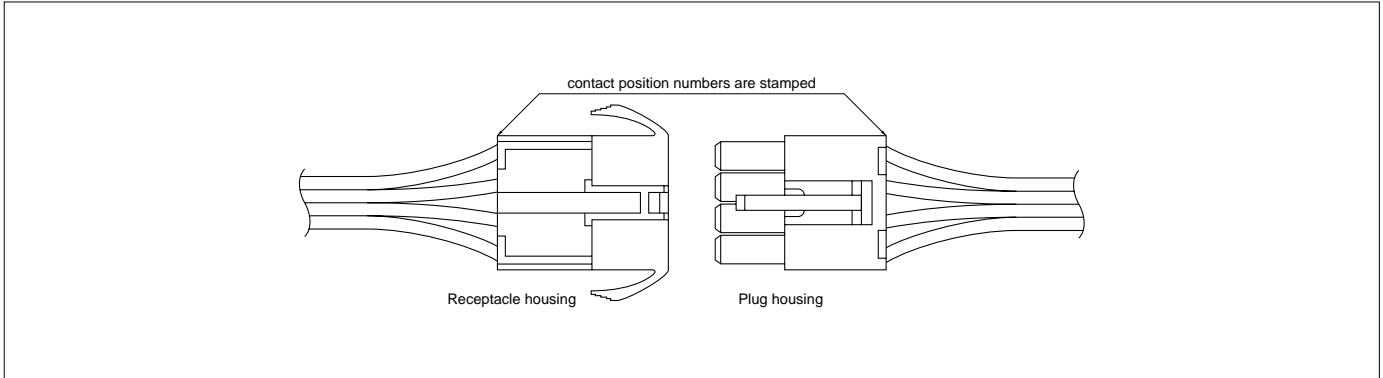

Panel layout

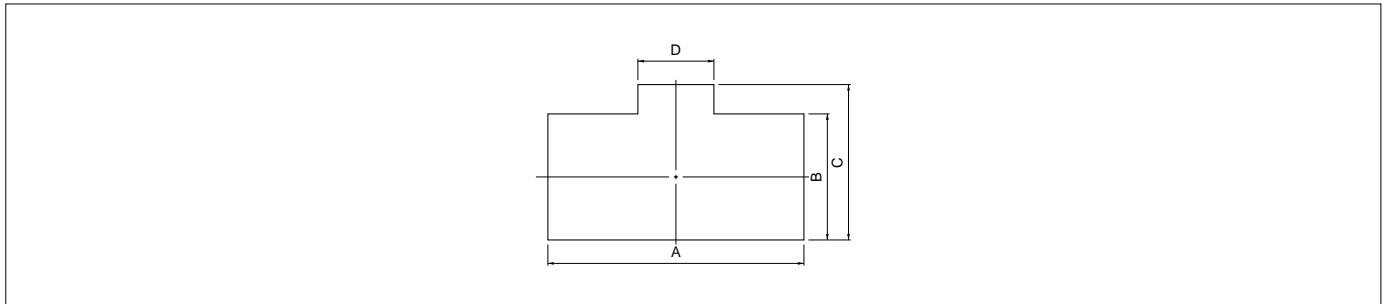

| Circuits | Receptacle housing Model No. | Panel hole dimensions mm(in.) | | | | General tolerance ± 0.13 ($\pm .005$) | Applicable panel thickness mm(in.) |
|----------|------------------------------|-------------------------------|------------|------------|-----------|---|------------------------------------|
| | | A | B | C | D | | |
| 2 | ELR-02V | 15.0(.591) | 6.0(.236) | 6.85(.270) | 5.2(.205) | 0.8 to 2.0 (.031 to .079) | |
| 3 | ELR-03V | 19.7(.776) | 6.0(.236) | 6.85(.270) | 5.2(.205) | | |
| 4 | ELR-04V | 24.2(.953) | 6.0(.236) | 6.85(.270) | 5.2(.205) | | |
| | ELR-04NV | 15.6(.614) | 10.6(.417) | 11.6(.457) | 5.2(.205) | | |
| 6 | ELR-06V | 19.7(.776) | 10.2(.402) | 11.1(.437) | 5.2(.205) | | |
| 9 | ELR-09V | 19.7(.776) | 14.8(.583) | 15.7(.618) | 5.2(.205) | | |
| 12 | ELR-12V | 24.2(.953) | 14.8(.583) | 15.7(.618) | 5.2(.205) | | |
| 15 | ELR-15V | 28.7(1.130) | 14.8(.583) | 15.7(.618) | 5.2(.205) | | |

Note:

1. Punch holes in the panel according to the sketch and table shown above. Burrs must be removed.
2. The strength of the panel must be considered when punching two or more holes.
3. The connector must be inserted from the same side as the hole is punched.

Assembly layout

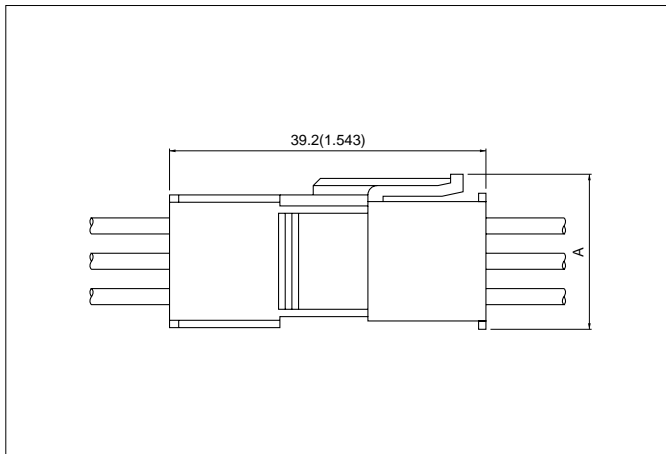

| Circuits | Dimensions A mm(in.) |
|-------------------------------------|----------------------|
| 2 to 4 (Single-line arrangement) | 10.4(.409) |
| 4 (Double-line arrangement) | 15.2(.598) |
| 6 | 14.9(.587) |
| 9 to 15 | 19.4(.764) |

Applicator for the semi-automatic press AP-K2N

| Contact | Crimp applicator MKS-L | | Compact Crimp applicator MKS-LS | | Strip-crimp applicator MKS-SC |
|---------------|------------------------|----------------------|---------------------------------|----------------------|-------------------------------|
| | with safety cover | without safety cover | with safety cover | without safety cover | with safety cover |
| SLF-01T-P1.3E | APLMK SLF/M01-13E | APLNC SLF/M01-13E | - | - | APLSC SLF/M01-13E |
| SLM-01T-P1.3E | APLMK SLF/M01-13E | APLNC SLF/M01-13E | - | - | APLSC SLF/M01-13E |
| SLF-41T-P1.3E | APLMK SLF/M41-13E | APLNC SLF/M41-13E | - | - | APLSC SLF/M41-13E |
| SLM-41T-P1.3E | APLMK SLF/M41-13E | APLNC SLF/M41-13E | - | - | APLSC SLF/M41-13E |
| SLF-42T-P1.3E | APLMK SLF/M42-13E | APLNC SLF/M42-13E | - | - | - |
| SLM-42T-P1.3E | APLMK SLF/M42-13E | APLNC SLF/M42-13E | - | - | - |