

INSULATED TERMINALS

INSULATED TERMINALS

Kompress Terminals are produced to comply generally with the requirements of BS6516 part 2: 1990 and are supplied in accordance with our ISO 9002 accredited certification.

They are manufactured from high conductivity copper or brass, electro tinned for corrosion resistance.

All Kompress Terminals feature a bell mouthed barrel for faster and easier conductor entry.

INSULATED VINYL GRIP (VG)

Kompress Insulated Vinyl Grip (VG) Terminals feature vinyl insulation support.

INSULATED COPPER GRIP (CG)

Kompress Insulated Copper Grip (CG) Terminals are most suitable for applications where they will be subject to vibration or frequent flexing.

NON INSULATED TERMINALS

Most Kompress Terminals are available without insulation, if required (see table opposite).

HOW TO SPECIFY

The Kompress part numbering system has been carefully devised to help the specifier understand and recognise each element of the code. This simple part numbering system makes specifying easy without constant reference to the catalogue.

To create your code, start by specifying type and size. For example, to specify Ring for 2.5mm² cable to fit 4.3mm (or M4) stud.

e.g. R 2.5 - 4.3

If insulation required, add prefix 'I'

e.g. IR 2.5 - 4.3

To specify either Vinyl Grip or Copper Grip
add suffix VG or CG.

e.g. IR 2.5 - 4.3 (VG)

If VG or CG not specified, the most common version will be supplied
(see Terminal Types chart on opposite page).

INSULATED TERMINALS



TERMINAL TYPES

CONNECTION TYPE	NORMALLY SUPPLIED AS VINYL GRIP (VG)									NORMALLY SUPPLIED AS COPPER GRIP (VG)							NORMALLY SUPPLIED AS NYLON GRIP (NG)		
	RINGS	FORKS	FLANGED FORKS	LOCKING FORKS	HOOKS	BLADES	HOOK BLADES	PINS	SPLICES	TOTALLY INSUL. PIGGY BACK	PUSH-ONS FEMALE	PUSH-ONS MALE	TOTALLY INSUL. PUSH-ONS	PIGGY BACKS	SOCKETS	BULLETS	END SPLICES	FULLY INSUL. FEMALE	FULLY INSUL. MALE
VINYL GRIP	●	●	●	●	●	●	●	●	●		●	●		●	●	●			
COPPER GRIP	●	●	●	●	●	●	●	●		●	●	●	●	●	●	●			
NON INSULATED	●	●	●	●	●	●	●	●	●		●	●		●					
NYLON GRIP																	●	●	●

ISO 9001 ACCREDITATION



PRODUCT PROFILE

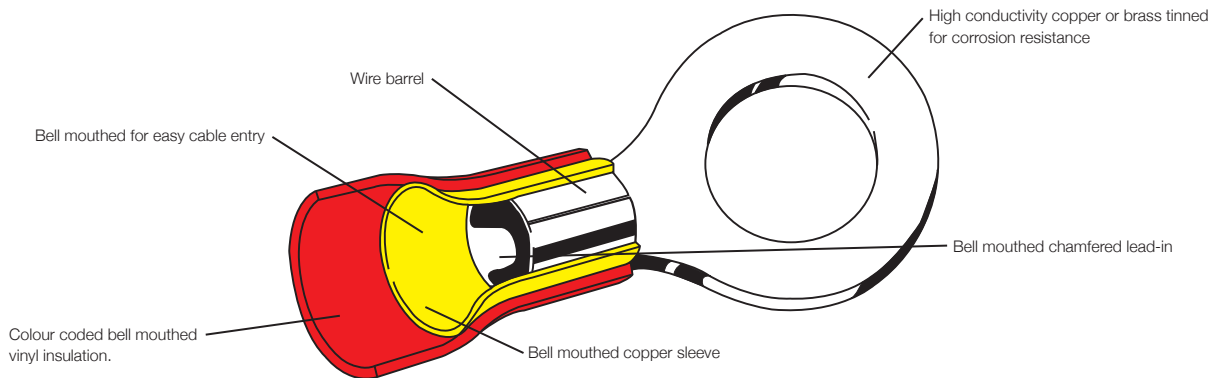

INSULATED TERMINAL TOOLS

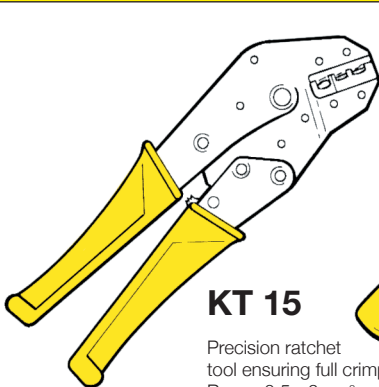

KT 15

Precision ratchet tool ensuring full crimp. Range 0.5 - 6mm²

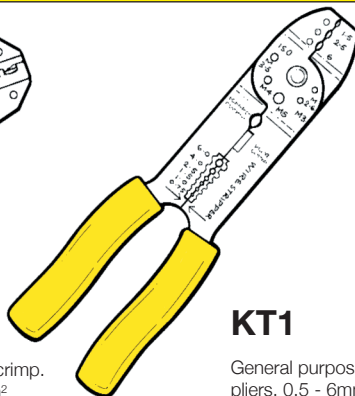

KT1

General purpose service pliers. 0.5 - 6mm²

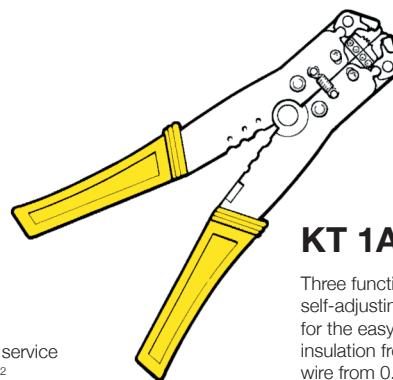

KT 1AS

Three function tool featuring self-adjusting wire stripper for the easy removal of insulation from all types of wire from 0.13 - 6mm²

While every effort has been made to ensure that the information contained in this catalogue is accurate, Kompres reserves the right to amend the size and specifications of its products in line with its policy of continuing improvement and development.

INSULATED TERMINALS

0.5 - 1.5mm²

RINGS	FORKS	FLANGED FORKS	LOCKING FORKS	HOOKS	BLADES	HOOK BLADES	PINS	SPLICES	PARALLEL SPLICES
IR 1.5-2.2 IR 1.5-3.2 IR 1.5-3.2 N IR 1.5-3.7 IR 1.5-4.3 IR 1.5-5.3 IR 1.5-6.5 IR 1.5-8.5 IR 1.5-10 IR 1.5-12	IF 1.5-3.2 IF 1.5-3.2 N IF 1.5-3.7 IF 1.5-3.7 N IF 1.5-4.3 IF 1.5-4.3 N IF 1.5-5.3 IF 1.5-5.3 N IF 1.5-6.5	IFF 1.5-3.7 IFF 1.5-3.7 N IFF 1.5-4.3 IFF 1.5-4.3 N IFF 1.5-5.3	ILF 1.5-3.7 ILF 1.5-4.3 ILF 1.5-5.3	IH 1.5-3.7 IH 1.5-4.3 IH 1.5-5.3	IBL 1.5-10 IBL 1.5-11 IBL 1.5-14 IBL 1.5-18	IHBL 1.5-3.0 IHBL 1.5-4.6	IP 1.5-9.5 IP 1.5-12	IS 1.5-1.5	IPS 1.5

1.5 - 2.5mm²







RINGS	FORKS	FLANGED FORKS	LOCKING FORKS	HOOKS	BLADES	HOOK BLADES	PINS	SPLICES	PARALLEL SPLICES
IR 2.5-2.2 IR 2.5-3.2 IR 2.5-3.7 IR 2.5-3.7 N IR 2.5-4.3 IR 2.5-4.3 N IR 2.5-5.3 IR 2.5-6.5 IR 2.5-8.5 IR 2.5-10 IR 2.5-12	IF 2.5-3.2 IF 2.5-3.2 N IF 2.5-3.7 IF 2.5-3.7 N IF 2.5-4.3 IF 2.5-4.3 N IF 2.5-5.3 IF 2.5-6.5 IF 2.5-8.5	IFF 2.5-3.7 IFF 2.5-3.7 N IFF 2.5-4.3 IFF 2.5-4.3 N IFF 2.5-5.3	ILF 2.5-3.7 ILF 2.5-4.3 ILF 2.5-5.3	IH 2.5-3.7 IH 2.5-4.3 IH 2.5-5.3	IBL 2.5-9 IBL 2.5-18	IHBL 2.5-3.0 IHBL 2.5-4.6	IP 2.5-9.5 IP 2.5-12	IS 2.5-2.5	IPS 2.5



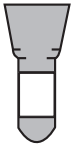
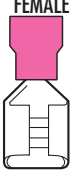

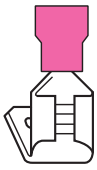

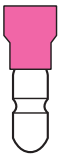

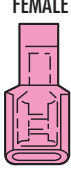
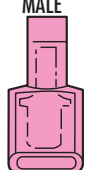
4 - 6mm²

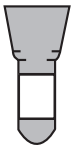

RINGS	FORKS	FLANGED FORKS	LOCKING FORKS	HOOKS	BLADES	HOOK BLADES	PINS	SPLICES
IR 6-3.2 IR 6-3.7 IR 6-4.3 IR 6-4.3 N IR 6-5.3 IR 6-6.5 IR 6-8.5 IR 6-10 IR 6-12	IF 6-3.7 IF 6-4.3 IF 6-5.3 IF 6-6.5 IF 6-8.5 IF 6-10	IFF 6-3.7 IFF 6-4.3 IFF 6-5.3	ILF 6-3.7 ILF 6-4.3 ILF 6-5.3	IH 6-3.7 IH 6-4.3 IH 6-5.3	IBL 6-10 IBL 6-18	IHBL 6-4.6	IP 6-14	IS 6-6

INSULATED TERMINALS

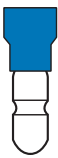

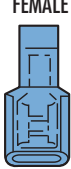
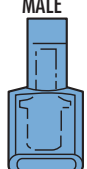

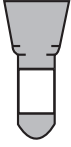
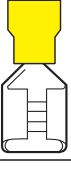

END SPLICES	PUSH-ONS FEMALE	PUSH-ONS MALE	TOTALLY INSUL. PUSH-ONS	PIGGY BACKS	TOTALLY INSUL. PIGGY BACKS	BULLETS	SOCKETS	FULLY INSUL. FEMALE	FULLY INSUL. MALE
									
IES 1.5(NG)	IPO 1.5-2.8 IPO 1.5-2.8 X IPO 1.5-4.8 IPO 1.5-4.8 X IPO 1.5-6.3	IPOM 1.5-4.8 IPOM 1.5-6.3	IPO 1.5-2.8 TI IPO 1.5-2.8 XTI IPO 1.5-4.8 TI IPO 1.5-4.8 XTI IPO 1.5-6.3 TI	IPB 1.5-6.3	IPB 1.5-6.3 TI	IB 1.5-4.0	ISO 1.5-4.0	IPO 1.5-6.3 FI (NG)	IPOM 1.5-6.3 FI (NG)

END SPLICES	PUSH-ONS FEMALE	PUSH-ONS MALE	TOTALLY INSUL. PUSH-ONS	PIGGY BACKS	TOTALLY INSUL. PIGGY BACKS	BULLETS	SOCKETS	FULLY INSUL. FEMALE	FULLY INSUL. MALE
									
IES 2.5(NG)	IPO 2.5-4.8 IPO 2.5-4.8 X IPO 2.5-6.3	IPOM 2.5-4.8 IPOM 2.5-6.3	IPO 2.5-4.8 TI IPO 2.5-4.8 XTI IPO 2.5-6.3 TI	IPB 2.5-6.3	IPB 2.5-6.3 TI	IB 2.5-4.0 IB 2.5-4.6 IB 2.5-5.0	ISO 2.5-4.0 ISO 2.5-5.0	IPO 2.5-6.3 FI (NG)	IPOM 2.5-6.3 FI (NG)

PARALLEL SPLICES	END SPLICES	PUSH-ONS FEMALE	PUSH-ONS MALE	TOTALLY INSUL. PUSH-ONS
				
IPS 6	IES 6 (NG)	IPO 6-6.3 IPO 6-9.5	IPOM 6-6.3	IPO 6-6.3 TI

END TERMINALS

0.5mm ² Conductor	0.75mm ² Conductor	1.0mm ² Conductor	1.5mm ² Conductor																																																				
																																																							
<table style="width: 100%; border-collapse: collapse;"> <thead> <tr> <th style="width: 50%;">REFERENCE</th> <th style="width: 50%;">COLOUR</th> </tr> </thead> <tbody> <tr> <td>KPET 0.5 FD</td> <td>White </td> </tr> <tr> <td>KPET 0.5 G</td> <td>Orange </td> </tr> <tr> <td>KPET 0.5 FDT</td> <td>White </td> </tr> <tr> <td>KPET 0.5 GT</td> <td>Orange </td> </tr> <tr> <td>KPET 0.5 X2D</td> <td>White </td> </tr> </tbody> </table>	REFERENCE	COLOUR	KPET 0.5 FD	White	KPET 0.5 G	Orange	KPET 0.5 FDT	White	KPET 0.5 GT	Orange	KPET 0.5 X2D	White	<table style="width: 100%; border-collapse: collapse;"> <thead> <tr> <th style="width: 50%;">REFERENCE</th> <th style="width: 50%;">COLOUR</th> </tr> </thead> <tbody> <tr> <td>KPET 0.75 D</td> <td>Grey </td> </tr> <tr> <td>KPET 0.75 F</td> <td>Blue </td> </tr> <tr> <td>KPET 0.75 G</td> <td>White </td> </tr> <tr> <td>KPET 0.75 DT</td> <td>Grey </td> </tr> <tr> <td>KPET 0.75 FT</td> <td>Blue </td> </tr> <tr> <td>KPET 0.75 GT</td> <td>White </td> </tr> <tr> <td>KPET 0.75 X2D</td> <td>Grey </td> </tr> </tbody> </table>	REFERENCE	COLOUR	KPET 0.75 D	Grey	KPET 0.75 F	Blue	KPET 0.75 G	White	KPET 0.75 DT	Grey	KPET 0.75 FT	Blue	KPET 0.75 GT	White	KPET 0.75 X2D	Grey	<table style="width: 100%; border-collapse: collapse;"> <thead> <tr> <th style="width: 50%;">REFERENCE</th> <th style="width: 50%;">COLOUR</th> </tr> </thead> <tbody> <tr> <td>KPET 1.0 FD</td> <td>Red </td> </tr> <tr> <td>KPET 1.0 G</td> <td>Yellow </td> </tr> <tr> <td>KPET 1.0 FDT</td> <td>Red </td> </tr> <tr> <td>KPET 1.0 GT</td> <td>Yellow </td> </tr> <tr> <td>KPET 1.0 X2D</td> <td>Red </td> </tr> </tbody> </table>	REFERENCE	COLOUR	KPET 1.0 FD	Red	KPET 1.0 G	Yellow	KPET 1.0 FDT	Red	KPET 1.0 GT	Yellow	KPET 1.0 X2D	Red	<table style="width: 100%; border-collapse: collapse;"> <thead> <tr> <th style="width: 50%;">REFERENCE</th> <th style="width: 50%;">COLOUR</th> </tr> </thead> <tbody> <tr> <td>KPET 1.5 FD</td> <td>Black </td> </tr> <tr> <td>KPET 1.5 G</td> <td>Red </td> </tr> <tr> <td>KPET 1.5 FDT</td> <td>Black </td> </tr> <tr> <td>KPET 1.5 GT</td> <td>Red </td> </tr> <tr> <td>KPET 1.5 X2D</td> <td>Black </td> </tr> </tbody> </table>	REFERENCE	COLOUR	KPET 1.5 FD	Black	KPET 1.5 G	Red	KPET 1.5 FDT	Black	KPET 1.5 GT	Red	KPET 1.5 X2D	Black
REFERENCE	COLOUR																																																						
KPET 0.5 FD	White																																																						
KPET 0.5 G	Orange																																																						
KPET 0.5 FDT	White																																																						
KPET 0.5 GT	Orange																																																						
KPET 0.5 X2D	White																																																						
REFERENCE	COLOUR																																																						
KPET 0.75 D	Grey																																																						
KPET 0.75 F	Blue																																																						
KPET 0.75 G	White																																																						
KPET 0.75 DT	Grey																																																						
KPET 0.75 FT	Blue																																																						
KPET 0.75 GT	White																																																						
KPET 0.75 X2D	Grey																																																						
REFERENCE	COLOUR																																																						
KPET 1.0 FD	Red																																																						
KPET 1.0 G	Yellow																																																						
KPET 1.0 FDT	Red																																																						
KPET 1.0 GT	Yellow																																																						
KPET 1.0 X2D	Red																																																						
REFERENCE	COLOUR																																																						
KPET 1.5 FD	Black																																																						
KPET 1.5 G	Red																																																						
KPET 1.5 FDT	Black																																																						
KPET 1.5 GT	Red																																																						
KPET 1.5 X2D	Black																																																						

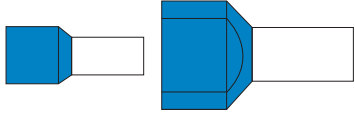
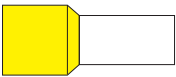
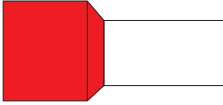
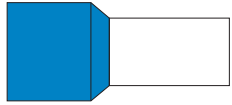
16mm ² Conductor	25mm ² Conductor	35mm ² Conductor	50mm ² Conductor																																		
 <p style="text-align: center; font-size: small;">Shown 80% Actual Size</p>	 <p style="text-align: center; font-size: small;">Shown 80% Actual Size</p>	 <p style="text-align: center; font-size: small;">Shown 80% Actual Size</p>	 <p style="text-align: center; font-size: small;">Shown 80% Actual Size</p>																																		
<table style="width: 100%; border-collapse: collapse;"> <thead> <tr> <th style="width: 50%;">REFERENCE</th> <th style="width: 50%;">COLOUR</th> </tr> </thead> <tbody> <tr> <td>KEPT 16 D</td> <td>Blue </td> </tr> <tr> <td>KEPT 16 F</td> <td>Ivory </td> </tr> <tr> <td>KEPT 16 G</td> <td>Green </td> </tr> <tr> <td>KEPT 16 FDT</td> <td>Ivory </td> </tr> <tr> <td>KEPT 16 GT</td> <td>Green </td> </tr> <tr> <td>KEPT 16 X2D</td> <td>Blue </td> </tr> </tbody> </table>	REFERENCE	COLOUR	KEPT 16 D	Blue	KEPT 16 F	Ivory	KEPT 16 G	Green	KEPT 16 FDT	Ivory	KEPT 16 GT	Green	KEPT 16 X2D	Blue	<table style="width: 100%; border-collapse: collapse;"> <thead> <tr> <th style="width: 50%;">REFERENCE</th> <th style="width: 50%;">COLOUR</th> </tr> </thead> <tbody> <tr> <td>KPET 25 D</td> <td>Yellow </td> </tr> <tr> <td>KPET 25 F</td> <td>Black </td> </tr> <tr> <td>KPET 25 G</td> <td>Brown </td> </tr> </tbody> </table>	REFERENCE	COLOUR	KPET 25 D	Yellow	KPET 25 F	Black	KPET 25 G	Brown	<table style="width: 100%; border-collapse: collapse;"> <thead> <tr> <th style="width: 50%;">REFERENCE</th> <th style="width: 50%;">COLOUR</th> </tr> </thead> <tbody> <tr> <td>KPET 35 FD</td> <td>Red </td> </tr> <tr> <td>KPET 35 G</td> <td>Beige </td> </tr> </tbody> </table>	REFERENCE	COLOUR	KPET 35 FD	Red	KPET 35 G	Beige	<table style="width: 100%; border-collapse: collapse;"> <thead> <tr> <th style="width: 50%;">REFERENCE</th> <th style="width: 50%;">COLOUR</th> </tr> </thead> <tbody> <tr> <td>KPET 50 FD</td> <td>Blue </td> </tr> <tr> <td>KPET 50 G</td> <td>Olive </td> </tr> </tbody> </table>	REFERENCE	COLOUR	KPET 50 FD	Blue	KPET 50 G	Olive
REFERENCE	COLOUR																																				
KEPT 16 D	Blue																																				
KEPT 16 F	Ivory																																				
KEPT 16 G	Green																																				
KEPT 16 FDT	Ivory																																				
KEPT 16 GT	Green																																				
KEPT 16 X2D	Blue																																				
REFERENCE	COLOUR																																				
KPET 25 D	Yellow																																				
KPET 25 F	Black																																				
KPET 25 G	Brown																																				
REFERENCE	COLOUR																																				
KPET 35 FD	Red																																				
KPET 35 G	Beige																																				
REFERENCE	COLOUR																																				
KPET 50 FD	Blue																																				
KPET 50 G	Olive																																				

END TERMINAL TOOLS

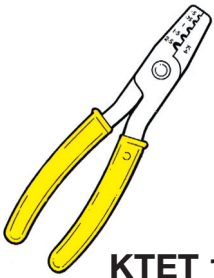

KTET 1

General purpose service pliers for End Terminals range - 0.25-2.5mm²

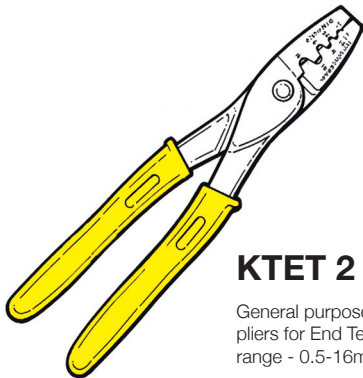

KTET 2

General purpose service pliers for End Terminals range - 0.5-16mm²

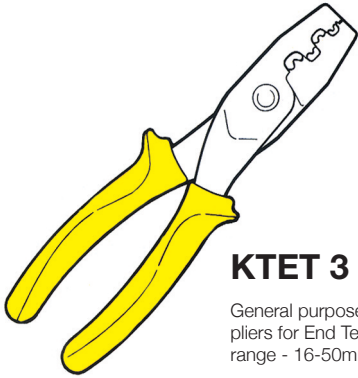

KTET 3

General purpose service pliers for End Terminals range - 16-50mm²

END TERMINALS



2.5mm ² Conductor	4mm ² Conductor	6mm ² Conductor	10mm ² Conductor																																				
<table border="0"> <thead> <tr> <th>REFERENCE</th> <th>COLOUR</th> </tr> </thead> <tbody> <tr> <td>KPET 2.5 F</td> <td>Grey </td> </tr> <tr> <td>KPET 2.5 GD</td> <td>Blue </td> </tr> <tr> <td>KPET 2.5 X2D</td> <td>Blue </td> </tr> </tbody> </table>	REFERENCE	COLOUR	KPET 2.5 F	Grey	KPET 2.5 GD	Blue	KPET 2.5 X2D	Blue	<table border="0"> <thead> <tr> <th>REFERENCE</th> <th>COLOUR</th> </tr> </thead> <tbody> <tr> <td>KPET 4 F</td> <td>Orange </td> </tr> <tr> <td>KPET 4 GD</td> <td>Grey </td> </tr> <tr> <td>KPET 4 X2D</td> <td>Grey </td> </tr> </tbody> </table>	REFERENCE	COLOUR	KPET 4 F	Orange	KPET 4 GD	Grey	KPET 4 X2D	Grey	<table border="0"> <thead> <tr> <th>REFERENCE</th> <th>COLOUR</th> </tr> </thead> <tbody> <tr> <td>KPET 6 D</td> <td>Yellow </td> </tr> <tr> <td>KPET 6 F</td> <td>Green </td> </tr> <tr> <td>KPET 6 G</td> <td>Black </td> </tr> <tr> <td>KPET 6 X2D</td> <td>Yellow </td> </tr> </tbody> </table>	REFERENCE	COLOUR	KPET 6 D	Yellow	KPET 6 F	Green	KPET 6 G	Black	KPET 6 X2D	Yellow	<table border="0"> <thead> <tr> <th>REFERENCE</th> <th>COLOUR</th> </tr> </thead> <tbody> <tr> <td>KPET 10 D</td> <td>Red </td> </tr> <tr> <td>KPET 10 F</td> <td>Brown </td> </tr> <tr> <td>KPET 10 G</td> <td>Ivory </td> </tr> <tr> <td>KPET 10 X2D</td> <td>Red </td> </tr> </tbody> </table>	REFERENCE	COLOUR	KPET 10 D	Red	KPET 10 F	Brown	KPET 10 G	Ivory	KPET 10 X2D	Red
REFERENCE	COLOUR																																						
KPET 2.5 F	Grey																																						
KPET 2.5 GD	Blue																																						
KPET 2.5 X2D	Blue																																						
REFERENCE	COLOUR																																						
KPET 4 F	Orange																																						
KPET 4 GD	Grey																																						
KPET 4 X2D	Grey																																						
REFERENCE	COLOUR																																						
KPET 6 D	Yellow																																						
KPET 6 F	Green																																						
KPET 6 G	Black																																						
KPET 6 X2D	Yellow																																						
REFERENCE	COLOUR																																						
KPET 10 D	Red																																						
KPET 10 F	Brown																																						
KPET 10 G	Ivory																																						
KPET 10 X2D	Red																																						

70mm ² Conductor	95mm ² Conductor	120mm ² Conductor	150mm ² Conductor																
Shown 80% Actual Size	Shown 80% Actual Size	Shown 80% Actual Size	Shown 80% Actual Size																
<table border="0"> <thead> <tr> <th>REFERENCE</th> <th>COLOUR</th> </tr> </thead> <tbody> <tr> <td>KPET 70</td> <td>Yellow </td> </tr> </tbody> </table>	REFERENCE	COLOUR	KPET 70	Yellow	<table border="0"> <thead> <tr> <th>REFERENCE</th> <th>COLOUR</th> </tr> </thead> <tbody> <tr> <td>KPET 95</td> <td>Red </td> </tr> </tbody> </table>	REFERENCE	COLOUR	KPET 95	Red	<table border="0"> <thead> <tr> <th>REFERENCE</th> <th>COLOUR</th> </tr> </thead> <tbody> <tr> <td>KPET 120</td> <td>Blue </td> </tr> </tbody> </table>	REFERENCE	COLOUR	KPET 120	Blue	<table border="0"> <thead> <tr> <th>REFERENCE</th> <th>COLOUR</th> </tr> </thead> <tbody> <tr> <td>KPET 150</td> <td>Yellow </td> </tr> </tbody> </table>	REFERENCE	COLOUR	KPET 150	Yellow
REFERENCE	COLOUR																		
KPET 70	Yellow																		
REFERENCE	COLOUR																		
KPET 95	Red																		
REFERENCE	COLOUR																		
KPET 120	Blue																		
REFERENCE	COLOUR																		
KPET 150	Yellow																		

END TERMINAL RATCHET TOOLS

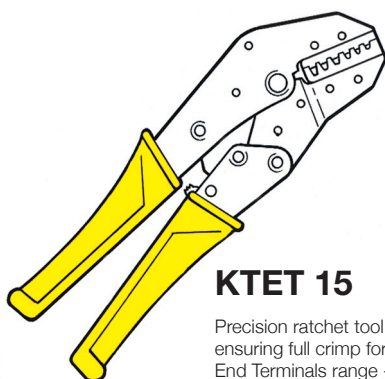

KTET 15

Precision ratchet tool ensuring full crimp for End Terminals range - 0.5-4mm²

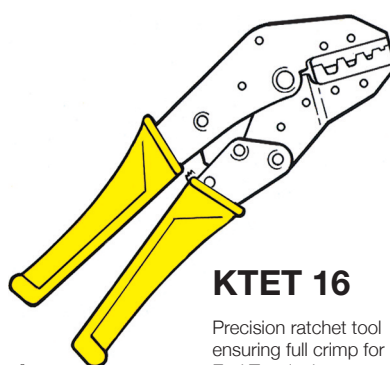

KTET 16

Precision ratchet tool ensuring full crimp for End Terminals range - 6-16mm²

LEGEND

- F = French
- G = German
- D = Din
- T = Tri-rated cables
- X2 = Twin
(to accept 2 cables)

The complete range of end terminals is also available non-insulated. To specify, replace KPET prefix with KUET